

Wireless World

ELECTRONICS, RADIO, TELEVISION

NOVEMBER 1963

Editor:

F. L. DEVEREUX, B.Sc.

Assistant Editor:

H. W. BARNARD

Editorial:

P. R. DARRINGTON

D. C. ROLFE

D. R. WILLIAMS

Drawing Office:

H. J. COOKE

Production:

D. R. BRAY

Advertisement Manager:

G. BENTON ROWELL

- 529 Editorial Comment
- 530 *Wireless World* Audio Signal Generator
- 537 Commercial Literature
- 538 New Low-noise Transistor Circuit for Electrostatic Microphones
By P. J. Baxandall
- 543 Wescon 1963
- 545 Letters to the Editor
- 549 World of Wireless
- 551 News from Industry
- 553 Personalities
- 555 Manufacturers' Products
- 561 Firato 63 in Amsterdam
- 563 Genoa Fair 1963
- 564 Books Received
- 565 First International Telemetry Conference
- 568 Salon International Radio—Télévision
- 570 Why Coaxial Cables? *By "Cathode Ray"*
- 573 H.F. Predictions—November
- 574 Conferences and Exhibitions
- 576 November Meetings
- 578 Unbiased *By "Free Grid"*

Managing Director: W. E. Miller, M.A., M.Brit.I.R.E.

Iiffe Electrical Publications Ltd., Dorset House, Stamford Street, London, S.E.1

VOLUME 69 No. 11

PRICE: 2s 6d.

FIFTY-THIRD YEAR
OF PUBLICATION

Please address to Editor, Advertisement Manager or Publisher as appropriate

©Iiffe Electrical Publications Ltd., 1963. Permission in writing from the Editor must first be obtained before letter-press or illustrations are reproduced from this journal. Brief abstracts or comments are allowed provided acknowledgement to the journal is given.

PUBLISHED MONTHLY (4th Monday of preceding month). *Telephone:* Waterloo 3333 (70 lines). *Telegrams:* "Ethaworld, London, Telex." *Cables:* "Ethaworld, London, S.E.1." *Annual Subscriptions:* Home £2 0s. 0d. Overseas £2 5s. 0d. *Canada and U.S.A.* \$6.50. Second-class mail privileges authorized at New York, N.Y. BRANCH OFFICES: *BIRMINGHAM:* King Edward House, New Street, 2. *Telephone:* Midland 7191. *COVENTRY:* 8-10, Corporation Street. *Telephone:* Coventry 25210. *GLASGOW:* 62, Buchanan Street, C.1. *Telephone:* Central 1265-6. *MANCHESTER:* 260, Deansgate, 3. *Telephone:* Blackfriars 4412. *NEW YORK OFFICE:* U.S.A.: 111, Broadway, 6. *Telephone:* Digby 9-1197.

PY88-BOOSTER DIODE

*For Dual-Standard
T.V. Receivers*

**LINE OUTPUT
PENTODE
PL500
FOR DUAL-STANDARD
RECEIVERS**

It is important in dual-standard television receivers to ensure that the performance of the line timebase does not deteriorate when the receiver is switched from one line standard to another.

Most of the functions of the line timebase are critical in application and such changes in performance would therefore be noticed by the viewer. Thus consistency in performance must be achieved despite the fact that the energy requirements for 625-line operation are roughly half as great again as those of 405-line operation.

In many new dual-standard receivers, the task of ensuring comparable performance has been simplified by utilising the new Mullard line output pentode, type PL500. This new valve has improved ratings compared

WHAT'S NEW IN THE NEW SETS

These articles describe the latest Mullard developments for entertainment equipment

with valves previously recommended for 405-line operation. In particular, an exceptionally high ratio of anode current to screen-grid current is achieved by an entirely new form of anode—the 'cavitrapp' anode. With this construction, secondary-emission electrons from the anode—which contribute greatly to the screen-grid current—are recaptured by the partitions of the cavitrapp anode. Because of the improved current ratio, the PL500 is capable of delivering greater deflection power, which helps to prevent any significant change in performance between the two line standards.

THE PY88 is a Mullard television booster diode now to be encountered in the line timebase circuits of switchable receivers, especially in conjunction with the Mullard PL500 line output pentode.

Because of the excellent insulation between the heater and cathode, the PY88 has a high heater-to-cathode voltage rating of 6.6kV. The peak and average anode current ratings of the valve are also high—550 and 220mA respectively—but to achieve these it has been necessary to increase the heater voltage from the 19V required with the PY800 Mullard booster diode to 30V.

With its improved ratings, the PY88 is thus well equipped to meet the more stringent booster diode requirements of 625-line operation, and the valve is particularly suitable for stabilised timebase circuits using the PL500 high-output line pentode.

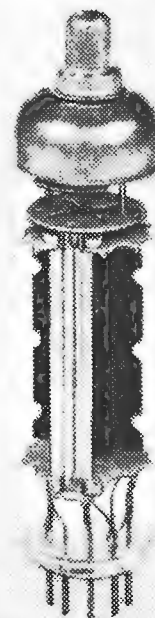

COMPLEMENTARY MATCHED PNP AND NPN TRANSISTORS FOR TRANSISTOR PORTABLES

Designed for use in transformerless audio amplifiers, the new Mullard audio frequency package—the LFK3—is now to be encountered in many portable receivers. The output pair of the package consists of the complementary matched p.n.p. and n.p.n. transistors types OC81 and AC127. The p.n.p. driver transistor type OC81D completes the package.

The current amplification factor of the output transistors is greater than 50 at 200mA and 38 at 300mA. The base currents of every pair are matched to within 20% at a collector cur-

rent of 50mA, and each output transistor is cross-matched with the driver transistor to give reduced current gain spreads.

The peak collector current rating of the output transistors is 300mA, which enables an output power of up to 500mW to be obtained using a 9V battery. The sensitivity of the package is such that outputs of up to 100mW can be achieved without a pre-amplifier, and outputs of up to 500mW necessitate only a simple single-transistor pre-amplifier.

MVE1974

International Exhibitions

THIS year's exhibition report season seems to have produced more than the usual crop. The glut is partly due to the fact that Continental radio shows have become either biennial or erratic and, in spite of much discussion and many attempts to arrive at some degree of rational distribution, are showing klystron tendencies to bunching. Last year there were no shows in Berlin, Paris or Amsterdam; this year they were all back again with some overlap both in time and in the goods exhibited. Paris had followed Amsterdam in opening its doors to foreign competitors, but Berlin awaits reciprocal agreements—notably with London—before admitting other nations' products.

It has often been suggested that instead of national shows there should be a single peripatetic international European radio and television show, but we do not think that this would ever be accepted because, with at least five countries interested in playing host, the gap would be too long to satisfy national requirements. In the U.K. this year's experience, of dropping the national show has taught everyone its importance as an annual sales stimulus at the start of the winter season. We do not think this unfortunate experiment is likely to be repeated.

There is always the possibility of holding national exhibitions annually and expanding each in turn into an international show, but this seems to us to be forcing the issue for the benefit of exhibitor organizers rather than for the benefit of buyers or manufacturers. It is permissible to ask why one wants an international exhibition in Europe at all. Certainly it is of interest for the natives of one country to be able, without travelling, to compare the methods of design and quality of finish of other people's goods, but until the Common Market has been running long enough for tariffs to have practically disappeared, and until all countries are participating, a foreign television set or radiogram has to be very good indeed to compete with the indigenous product.

Every industrial European nation has, or could soon acquire, the capacity to satisfy its home market; many have production methods, developed for cutting costs to compete with their own nationals, which give them a vast surplus capacity. This is a world problem and not one special to the radio industry. With home markets within sight of saturation, future markets must be sought in the emergent and developing countries of the world. It is to these spheres of interest that international competition will increasingly be directed and for which international exhibitions will have the greatest attraction.

The venue of international exhibitions can to some extent be decided by the competitive publicity of

exhibition organizers, but in general it is finally settled by inclination, by a consensus of acceptance by visitors. Whether buyers from the expanding overseas markets will prefer to come to Europe to make their decisions or whether they will expect us to demonstrate to their customers on the spot remains to be seen. Meanwhile we learn that one German manufacturer has, in the first nine months of this year, exhibited in no fewer than fourteen exhibitions in Europe, the Americas and north Africa.

Gatherings of the Clans

The announcement, recorded on p. 549 of this issue that the Institute of Electrical and Electronic Engineers is to open a branch in the U.K. and has obtained the consent of the Institution of Electrical Engineers to use part of their premises at 2 Savoy Hill, London, W.C.2, will be welcomed by all who believe that science (and with certain reservations technology) should be international. It should also give pleasure to sons of the Emerald Isle who have adopted electronics as a career, for the full title is to be the U.K. and Eire Section of the I.E.E.E.

One of the reasons given for the formation of this new Section is that it will provide the nucleus for English language conferences, for which there has been increasing interest throughout the European Region. The International Television Conference held in London in 1962 was a good example of Anglo-American co-operation between the British learned societies, for not only the I.E.E. but also the Brit. I.R.E., the Television Society and the British Kinematograph Society played an active part. No doubt the newly formed I.E.E.E. United Kingdom and Eire section will continue to encourage collaboration with *all* English speaking associations fostering allied interests and also with those of our European friends who favour English as the language for international exchange and pooling of knowledge.

This journal has often deplored the proliferation of conferences and conventions, particularly where this has arisen through mistaken motives of prestige, "empire building" and rivalry between organizations. In our rapidly developing field there is material enough for discussion without unnecessary duplication, and we congratulate the I.E.E.E. on its initiative and the I.E.E. on its magnanimity in providing a home for the new Section. Provided that the declared intention to keep the association on a strictly two-way exchange basis is adhered to, we see no foundation for any talk of takeover bids. Furthermore, the I.E.E.E. is a learned society and not a professional qualifying and regulating body.

Wireless World



AUDIO SIGNAL GENERATOR

TRANSISTOR DESIGN WITH SIMPLIFIED CALIBRATION

THE *W.W.* oscilloscope has been described in recent months, and as one of its main applications is the testing of audio amplifiers, we now introduce a signal source for this purpose. An incidental use for the instrument is the calibration of the oscilloscope, which will be described shortly.

The oscillator covers the range 10c/s to 100kc/s, which is more than sufficient for any audio testing, and square waves are available over the whole range. A constant-impedance (600Ω) sine-wave output is provided by a 40dB step attenuator and a continuous control up to IV r.m.s.

For several reasons, it was decided to use a moving-coil meter to indicate frequency, rather than the usual dial. The most important point is that only four easily-obtainable signals are required for the whole calibration. Secondly, frequency drift of the oscillator, which can happen in the best of circles,

is relatively unimportant, as it is immediately shown up by the meter, and calibration remains correct. Thirdly, the circuit required to operate the frequency meter is available for use in external frequency measurement.

Batteries are built into the unit, but are connected by a plug and socket, so that a common power supply can be used to feed the range of units we intend to describe. If it is desired to build only the oscillator part of the instrument, the switching will be considerably simplified, although difficulty with calibration will return.

Oscillator

At low frequencies, the ordinary type of oscillator using an inductance and capacitance to define its frequency becomes impracticable, as the values of

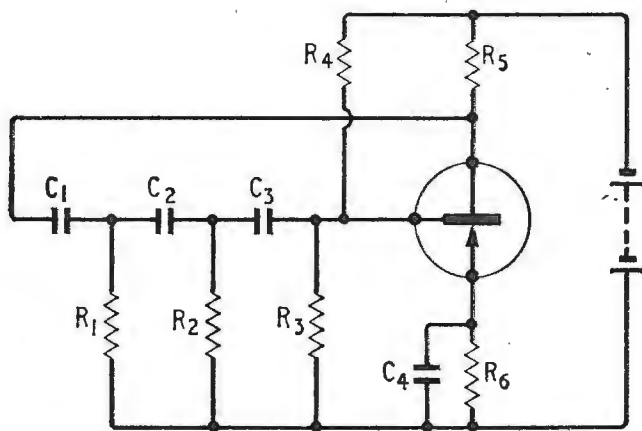

▲ Fig. 1. Phase-shift oscillator.

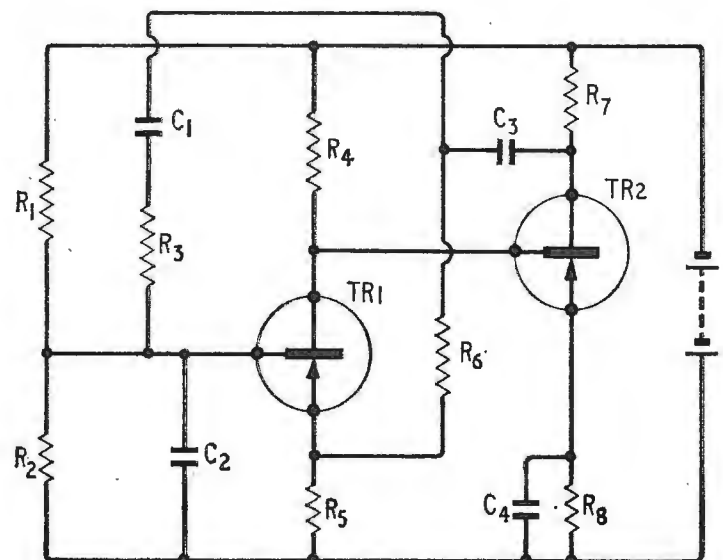

Fig. 2. Basic Wien-bridge oscillator. ►

these components are truly enormous. For instance, to obtain a frequency of 10c/s a tuned circuit of, say, 25 henrys and $10\mu\text{F}$ would be required, and components of this size cannot be varied very easily, apart from the low Q that would be obtained.

There are two ways out of this problem. One is to use two higher-frequency oscillators with easily accommodated tuned circuits, and make one oscillator beat with the other. To obtain 10c/s, the two frequencies could then be, say, 100kc/s and 100.01kc/s. The fundamental frequencies would be filtered out leaving the 10c/s. This method has its advantages, but the waveform at low frequencies tends to become a little ragged, due to one oscillator "pulling" the other into step during part of the cycle, and in any case, two oscillators are needed.

The most common approach, and the one we have employed, is to use a resistance-capacitance-tuned oscillator. This can be rather more difficult than the inductive type in several respects, but the techniques are fairly well established and little trouble should be experienced.

RC oscillators can be further sub-divided into phase-shift oscillators and Wien-bridge types. The phase shift variety, shown in Fig. 1, relies on the

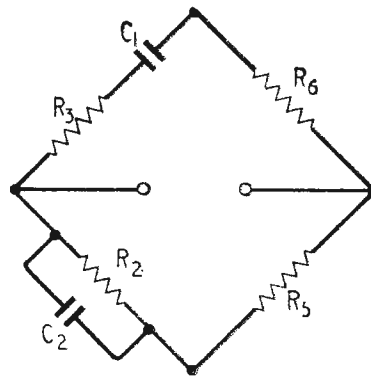

Fig. 3. Wien bridge, corresponding to left-hand side of Fig. 2.

Fig. 4. Super-alpha pair, giving very high input impedance.

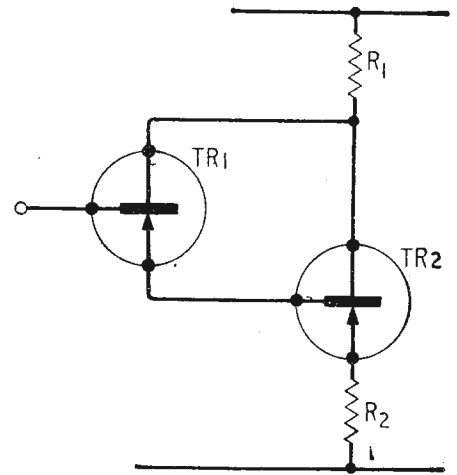
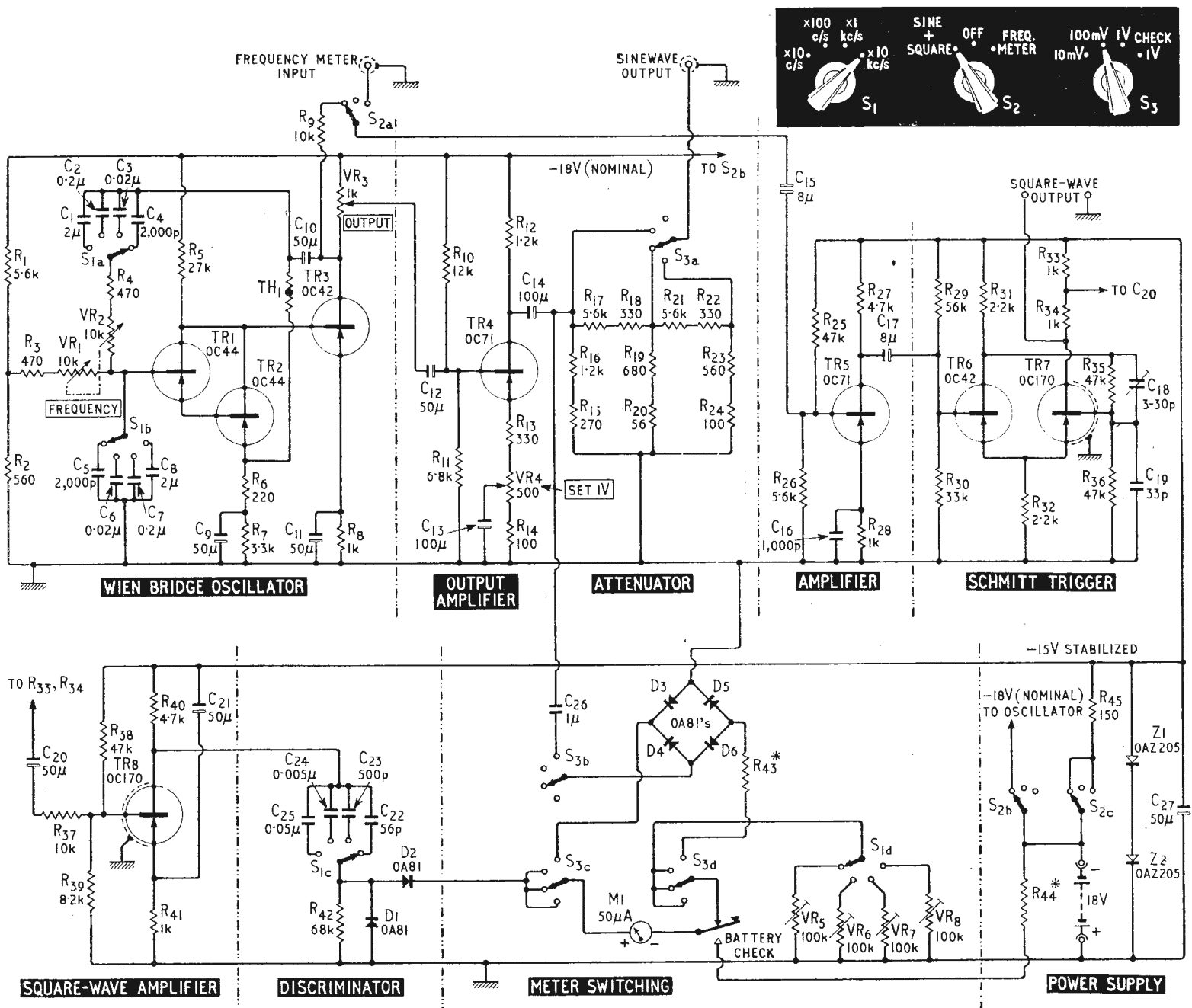

Fig. 5. Complete circuit diagram.



COMPONENT LIST

<p>R₁ 5.6kΩ R₂ 560Ω R₃ 470Ω R₄ 470Ω R₅ 27kΩ R₆ 220Ω R₇ 3.3kΩ R₈ 1kΩ R₉ 10kΩ R₁₀ 12kΩ R₁₁ 6.8kΩ R₁₂ 1.2kΩ R₁₃ 330Ω R₁₄ 100Ω R₁₅ 270Ω ±5% R₁₆ 1.2kΩ " " R₁₇ 5.6kΩ " " R₁₈ 330Ω " " R₁₉ 680Ω " " R₂₀ 56Ω " " R₂₁ 5.6kΩ " " R₂₂ 330Ω " " R₂₃ 560Ω " " R₂₄ 100Ω " " R₂₅ 47kΩ " " R₂₆ 5.6kΩ " " R₂₇ 4.7kΩ " " R₂₈ 1kΩ " " R₂₉ 56kΩ " " R₃₀ 33kΩ " " R₃₁ 2.2kΩ " " R₃₂ 2.2kΩ " " R₃₃ 1kΩ " " R₃₄ 1kΩ " " R₃₅ 47kΩ " " R₃₆ 47kΩ " " R₃₇ 10kΩ " " R₃₈ 47kΩ " "</p>	<p>R₃₉ 8.2kΩ R₄₀ 4.7kΩ R₄₁ 1kΩ R₄₂ 68kΩ R₄₃ 20-30kΩ* R₄₄ 400kΩ* R₄₅ 150Ω All resistors are ¼W, ±10%, except where otherwise specified. *Selected as explained in text. VR₁, VR₂ 10kΩ 2-gang log. VR₃ 1kΩ linear VR₄ 500Ω linear VR₅-VR₈ 100kΩ pre-sets (RADIO SPARES) TH₁ Standard Telephones R53 thermistor C₁ 2μF paper or electrolytic C₂ 0.2μF C₃ 0.02μF C₄ 0.002μF C₅ 0.002μF C₆ 0.02μF C₇ 0.2μF C₈ 2μF paper or electrolytic C₉ 50μF 15V C₁₀ 50μF 15V C₁₁ 50μF 6V C₁₂ 50μF 15V C₁₃ 100μF 6V C₁₄ 100μF 15V C₁₅ 8μF 15V reversible or 2×16μF in series C₁₆ 0.001μF C₁₇ 8μF 15V C₁₈ 3-30pF beehive trimmer C₁₉ 33pF C₂₀ 50μF 15V</p>	<p>C₂₁ 50μF 15V C₂₂ 56pF C₂₃ 500pF C₂₄ 0.005μF C₂₅ 0.05μF C₂₆ 1μF 15V reversible electrolytic or paper 25V C₂₇ 50μF TR1 OC44 TR2 OC44 TR3 OC42 TR4 OC71 TR5 OC71 TR6 OC42 TR7 OC170 TR8 OC170 Z₁ OAZ205 Z₂ OAZ205 D₁-D₆ OA81 M₁ 50μA meter Slow-motion drive (Jackson Bros. 4511 D.A.F.) Makaswitch shafting assemblies—3 off (Radiospares) Switch wafers 2-pole, 6-way—2 off (Radiospares) Switch wafers 3-pole, 4-way—3 off (Radiospares) Spacers for switch shafts—8, off medium (Radiospares) Burgess microswitch V4TI or similar. Coaxial sockets—2 off. 3-pin battery plug and socket. Battery clip connectors. Paxolin boards ⅛-in Thick. Turnet tags (Radiospares). Suitable handle. PP9 batteries—2 off.</p>
--	---	---

fact that a sine wave emerging from a CR circuit such as C₁ R₁ is shifted in phase with respect to the input by anything up to 90°. In actual fact, it is arranged that one such circuit shifts the phase 60° and a further two circuits are added to bring the total phase shift to 180°. The input to the transistor base is now in the correct phase to produce positive feedback from the collector, and provided there is enough of it, oscillation will ensue. The voltage gain of the transistor must be at least 29, to overcome losses in the phase-shift network.

This kind of RC oscillator is not very attractive if the frequency is to be varied, because it means either a triple-gang potentiometer or capacitor, and the most common type for signal-generator work is the Wien-bridge oscillator. The basic circuit is shown in Fig. 2.

The output from TR1 is amplified and reversed

in polarity by TR2, which feeds back to TR1 via the Wien network R₃ C₁ R₂ C₂. At a certain frequency, which can be shown to be equal to $1/(2\pi \sqrt{R_3 C_1 R_2 C_2})$, the signal voltage across R₂ C₂ is in phase with that across the whole network, and one-third as great. The voltage applied to the base of TR1 is therefore 180° out of phase with the collector voltage, and provided the gain of the two stages is three times, to make up the loss in the network, conditions are right for oscillation.

If matters were left like that, however, the Wien network would not have complete control of frequency. The amplifier itself would tend to exercise some influence over the phase angle, and the waveform would be anything but sinusoidal. The gain of the two-transistor loop is therefore made as high as possible, and negative feedback used. In Fig. 2, C₃, R₅ and R₆ perform this function, the values

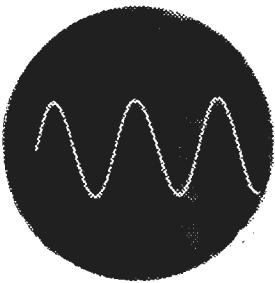

Fig. 6. Sine-wave output at 10c/s. Distortion is less than 0.25% over the range.

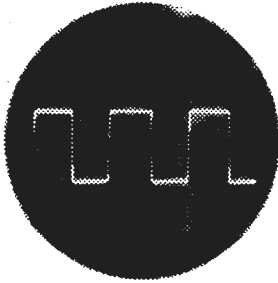

Fig. 7. Square wave at 100kc/s. Rise time is 0.15μsec.

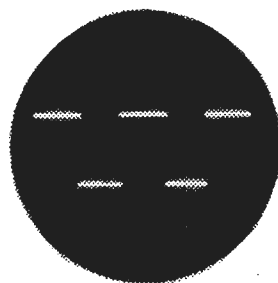

Fig. 8. 10c/s square wave. Oscilloscope amplifier is directly coupled.

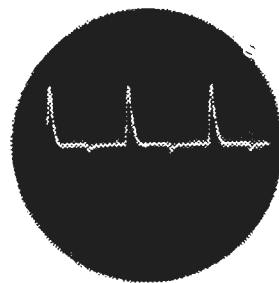

Fig. 9. Input to discriminator diodes across D₁, which rejects negative spike.

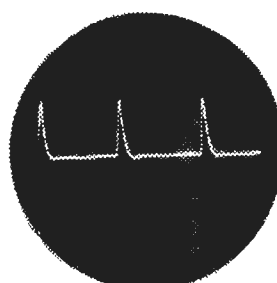

Fig. 10. Output of discriminator, constant-width pulses.

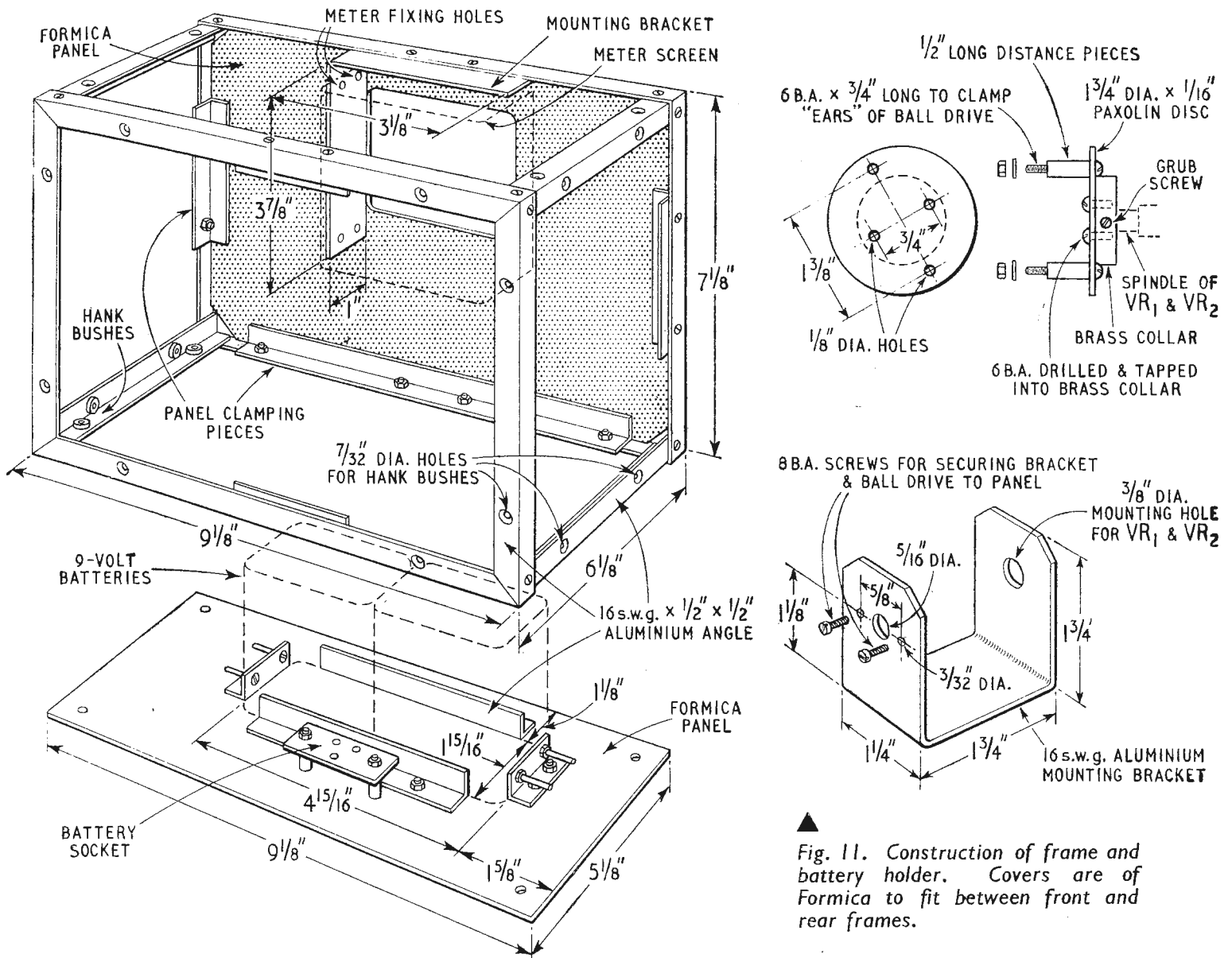

Fig. 11. Construction of frame and battery holder. Covers are of Formica to fit between front and rear frames.

being adjusted so that the total gain with feedback is 3. It can now be seen that the Wien network, R_5 and R_6 form a bridge, which is balanced at the frequency where $R = 1/2\pi fC$ assuming the R 's and C 's are equal. To maintain oscillation, the bridge, shown in Fig. 3, must be slightly unbalanced in order to supply an input to TR1.

Again, things are not quite as simple as this, and further modifications must be made. In an LC oscillator, the amplitude of oscillation builds up until the transistor or valve begins to distort, when gain falls and the amplitude is stabilized. Waveform does not suffer, as the LC circuit acts as a "flywheel" and smooths out the sine-wave. In an RC oscillator there is no "flywheel," and the oscillation will either collapse or build up until the result is almost a square wave. Some form of automatic level control is clearly required, and a thermistor is usually employed in the position of R_6 , Fig. 2. This is in the negative feedback path to TR2 emitter; if the output amplitude increases, more current is passed through the thermistor, the resistance of which is thereby reduced. This allows more negative feedback to be applied, which reduces the amplitude. In this way, the output is kept almost constant.

A further modification is required because of the low input impedance of TR1. This is of the order of a few thousand ohms in a common-emitter amplifier, even with an un-decoupled emitter resistor,

and with a convenient value of variable tuning resistor, R_2 , the transistor shunts the bottom reactive arm of the Wien bridge. A further transistor is therefore used to increase the input impedance of the first stage, the super-alpha-pair connection being employed. In the circuit shown in Fig. 4, the emitter current of TR1 is the base current of TR2, which in turn is less than the emitter current of TR2 by roughly the current gain of TR2. The base current of TR1 is therefore extremely small, negative feedback from the collector of TR2 serving to decrease it still further. In this way, the input impedance is raised to several hundred kilohms, and the Wien network is not shunted. Variation of the resistance arm of the bridge does not affect base current and gain to any marked extent, as it is already limited by the above mechanism.

Attenuator

The input to the attenuator is set to 1V r.m.s. exactly by the variation of negative feedback in the emitter of TR4 (Fig. 5). This signal is then attenuated in two 20dB steps to give outputs of 1V, 100mV and 10mV maximum in 600Ω . A continuous control of level is given by VR_3 .

Square-wave Shaper

After amplification in TR5, the sinusoidal signal is passed to TR6 and TR7 which, together, form a

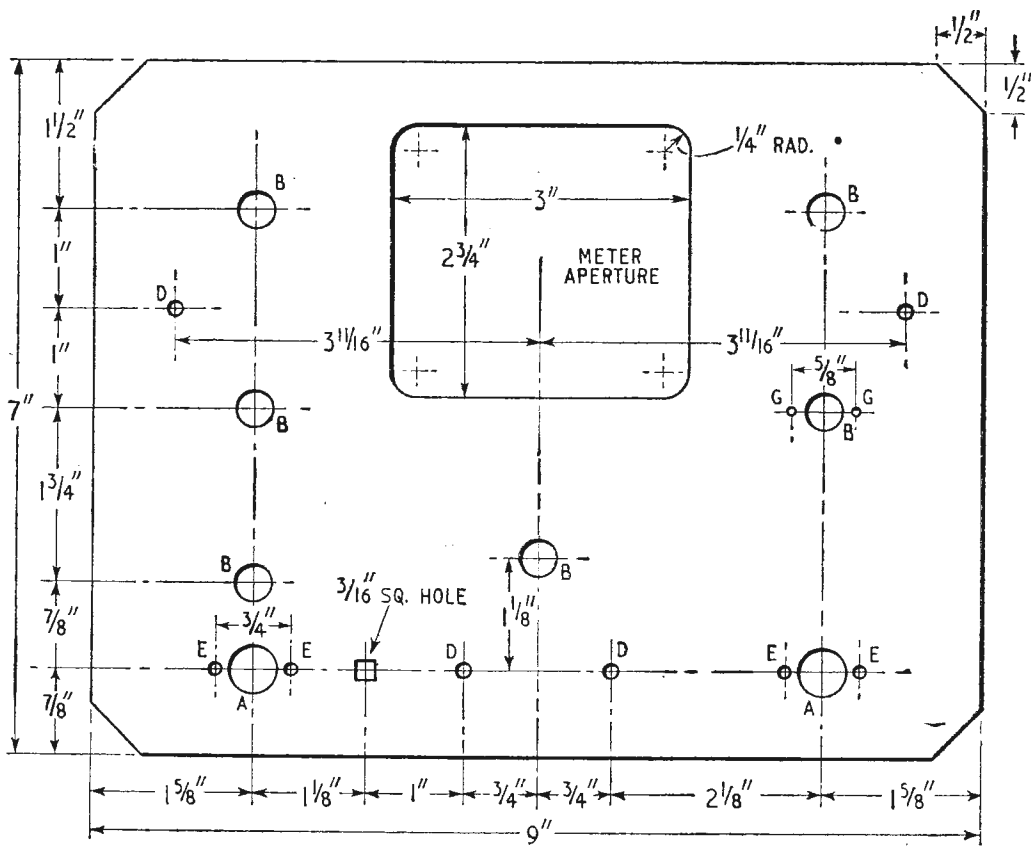
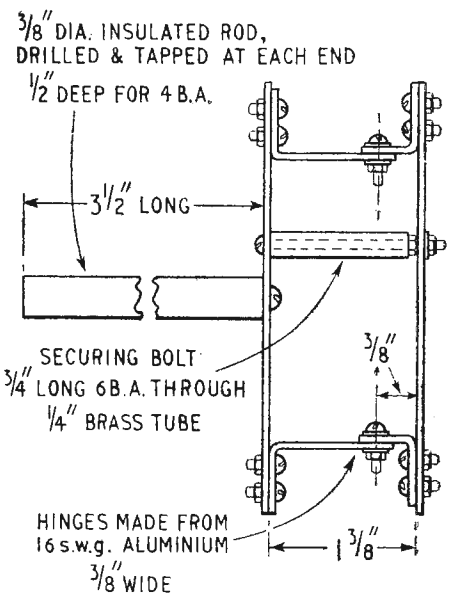
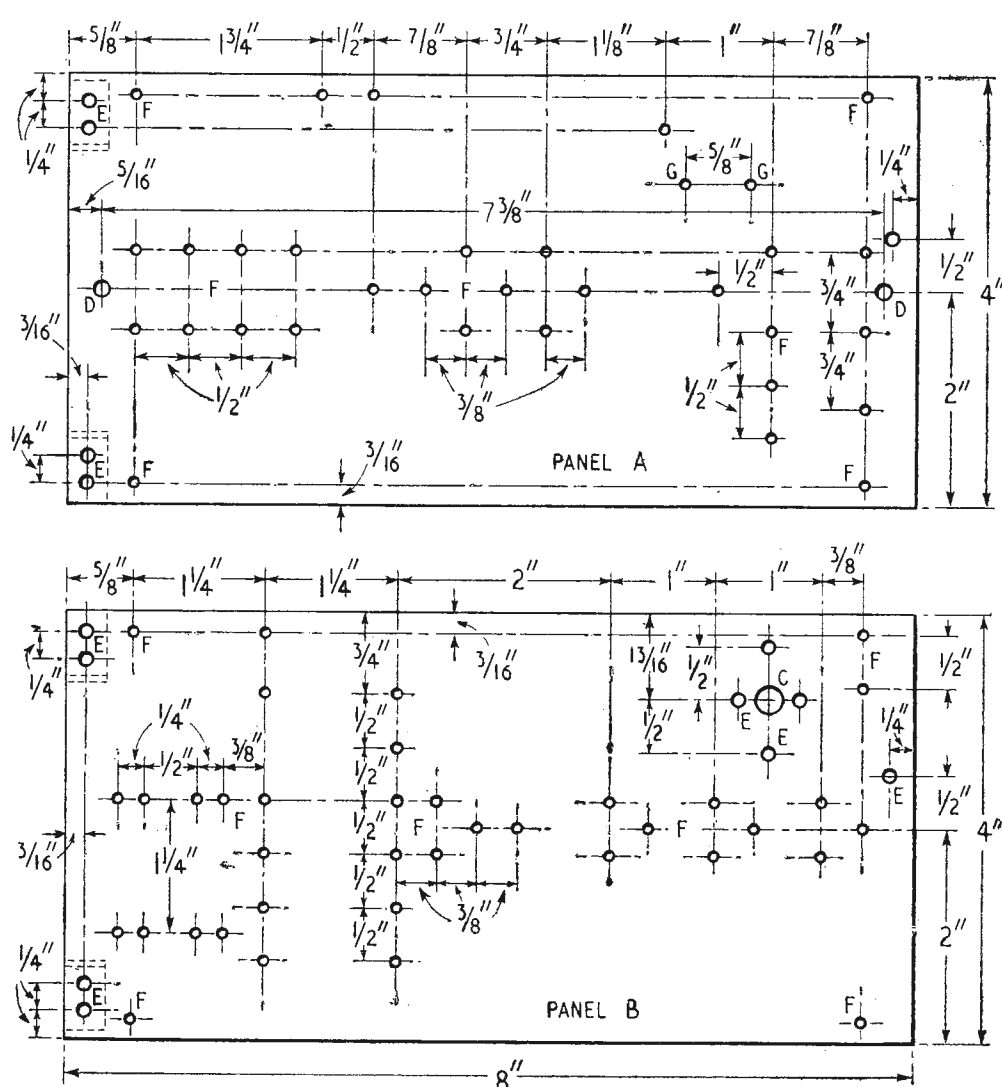

Fig. 12. Front panel drilling. Formica or Waverite gives an elegant finish. Meter hole is for Z. & I. meter.

Fig. 13. Component boards made from 1/8 in Paxolin. Boards are viewed from rear (turret tag side). Board A is nearest front panel.



DRILLING FOR ALL PANELS

- A — 1/2" DIA.
- B — 3/8" "
- C — 1/4" "
- D — 5/32" "
- E — 1/8" "
- F — 3/32" " FOR TURRET TAGS
- G — 3/32" "

Schmitt trigger, the output being a 6-V p.p. square wave, with a rise-time of 0.15 μ sec. The circuit operates over the whole range of the oscillator and is useful for many applications, apart from audio testing. C_{18} is adjusted to give neither an overshoot nor an "undershoot" on the positive-going edge. The output impedance is 2k Ω .

The square wave is amplified by TR8 and used to operate the frequency-meter circuit.

Frequency Meter

This part of the circuit is effectively an f.m. discriminator which needs no lining up. It has been used for a good many years in telemetry and instrumentation, and has also been used in f.m. tuners. The output of the square-wave amplifier is differentiated by one of the capacitors C_{22} - C_{25} and R_{42} , the result being a series of positive and negative spikes corresponding to positive and negative-going edges of the square wave. Negative spikes are suppressed by D_2 ,

and we are left with a series of positive spikes, of similar shape and energy content, which vary their spacing with frequency. The average voltage level of the spikes is now linearly dependent on frequency, and is applied to the meter which is calibrated 0-10, corresponding to the frequency ranges 10c/s-100c/s, 100c/s-1kc/s, 1kc/s-10kc/s, 10kc/s-100kc/s. D_1 helps to discharge the capacitor between pulses.

Power Supply

Batteries are built into the instrument although, as explained earlier, a common power supply will be described at some future date to power the range of test gear. If it is desired to run this instrument for long periods near a mains outlet, it will probably be found better to substitute a small mains supply for the batteries. A small transformer, silicon or metal rectifier and RC smoothing circuit would take up less room than batteries and would only cost about £2.

It will be seen that the square-wave shaper and frequency-meter circuit run from a Zener-diode-stabilized supply. The oscillator gives a reasonably constant output over a wide range of supply voltages and its supply is not stabilized.

Metering

The meter is employed in three functions. Primarily, it indicates frequency, as already described. Secondly, on the "Check IV" position, it enables the input to the attenuator to be set to 1V r.m.s. Its third function is needed only occasionally and is therefore selected by a biased push-button switch, when the battery voltage is displayed.

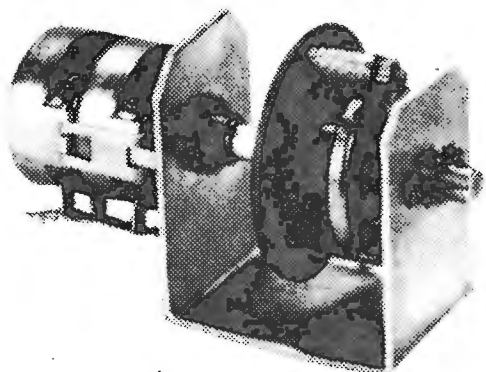

Fig. 14. Slow-motion drive assembly.

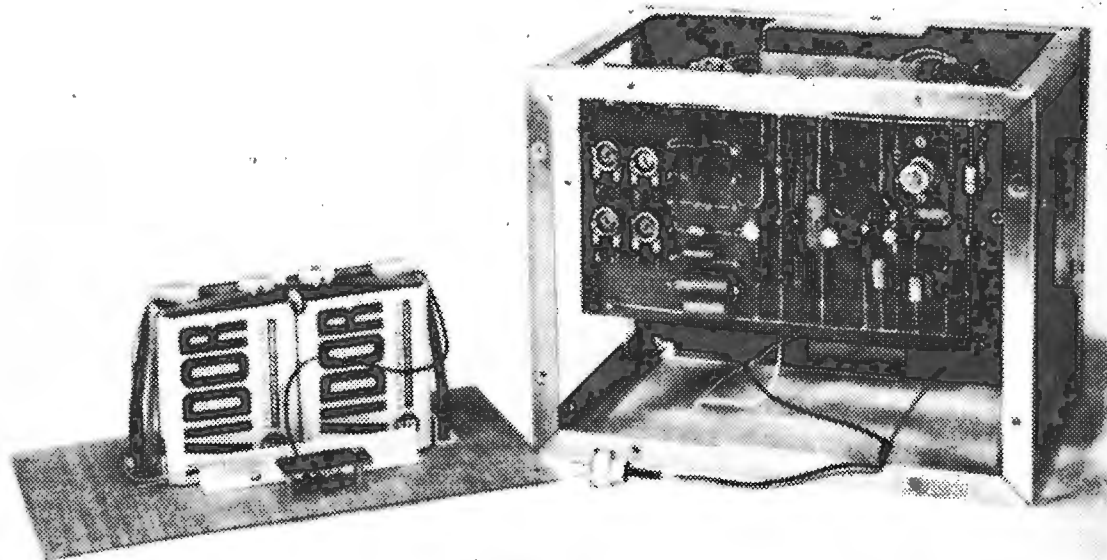

Fig. 15. Rear view of instrument, showing battery mounting. Rubber band holds batteries in place.

Calibration

As regards frequency, calibration is simplicity itself. The top range, 10kc/s-100kc/s, is calibrated by comparison with the 200kc/s long-wave Light Programme transmission from Droitwich. With the oscillator set to "Sine + Square," take a lead from the square wave output terminals to somewhere near a radio receiver, and adjust the oscillator for zero beat in the loudspeaker. VR_8 should then be adjusted to make the meter read "10."

The 1kc/s-10kc/s range is best calibrated by comparing it with the 10.125kc/s of a locked television line timebase. It is possible that, on some sets, a loop of wire connected to the frequency meter and held near the television line-output transformer will provide a suitable signal, but we found that the waveform gave misleading results. To overcome this, a parallel-tuned circuit should be made up to filter out harmonics of 10kc/s, the inductance acting as pick-up loop. Our tuned circuit was 31mH tuned by $0.01\mu\text{F}$ and $0.04\mu\text{F}$ in series, the output being taken across the $0.04\mu\text{F}$. The circuit can be adjusted by connecting it in the lead from the wiper of VR_3 to C_{12} , switching to "CHECK IV" on the range 10kc/s-100kc/s, and obtaining a null on the meter when the frequency of the oscillator is set to 10kc/s. (This range should be calibrated first.) As a matter of fact, our inductance took the form of a $\frac{1}{4}$ lb. reel of 32 s.w.g. double-silk-covered wire! Hold the loop near the line output stage, with the instrument set to "Frequency Meter," and adjust VR_7 until the meter reads "10.1".

The next range is 100c/s-1kc/s and here the 440c/s B.B.C. tuning note is used. This is transmitted for a few minutes before the opening of Home, Light and Third Network programmes, the latter being most convenient. In this case, the tone is transmitted from Zero-30 minutes to Zero-15 minutes and from Z-5 minutes to Z-3min. 20sec. The signal across the loudspeaker terminals or from the detector should be applied to the frequency meter and VR_6 adjusted until the meter reads "4.4". The lowest range, 10-100c/s, relies on the frequency of the mains. The output of a 6V heater transformer is fed to the "Frequency Meter Input" socket via a potentiometer, and with the instrument set to "Frequency Meter" VR_5 is adjusted until the meter reads "5".

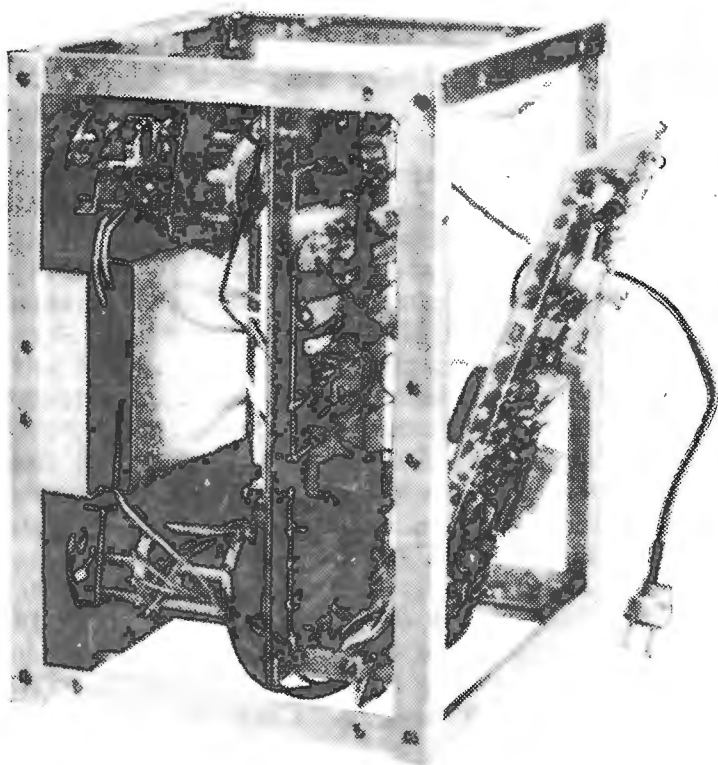

▲
Fig. 16. Top view. Rear panel (B) is normally held in place by nut.

Amplitude Calibration

To calibrate the "Check IV" level, an a.c. meter is required. The output of a 6V heater transformer is "potted down" by means of a $10k\Omega$ potentiometer until the voltage on the wiper is 1V r.m.s. This voltage is then applied to C_{26} , having first disconnected it from C_{14} , and the resistor in series with the meter selected so that the meter reads a convenient figure. "5" is the 1V level on our meter. This point on the meter scale can then be marked "SET LEVEL" if desired. To set up the level when the instrument is in operation, turn S_3 to "CHECK IV," set VR_3 (OUTPUT CONTROL) to maximum, and adjust VR_1 (SET IV) until the meter reads "5." VR_3 is calibrated by simply dividing the track into 10 equal-resistance divisions by means of an ohmmeter and marking them 0-10. R_5 should be selected to give a full-scale reading of 20V, when the "Battery Check" button is depressed. The meter, it will be seen, is a $50\mu A$ type, and this caused some worry, as not everyone can afford to take the obvious and easiest course of ordering from the makers' current catalogues at up to £3 a time. We did, however, locate a source of cheaper instruments. Z. and I. Aero Services Ltd., of 14 South Wharf Road, London, W.2, are able to supply meter movements at £1. These were originally used as Röntgen-hour indicators and need a new scale, which is best done by comparison with a test meter, keeping the scale vertical. This is the type of meter in the prototype instrument.

Construction

The drawings and photographs are self explanatory. The layout of the components is not critical, and almost any other form of construction would be equally suitable. Printed boards would be ideal, but the turret-tag method gives similar benefits and is probably easier to make. The slow-motion drive

is not essential, but was included in the prototype partly for its ease of adjustment and partly because it reverses the rotation of the potentiometers, so that clockwise rotation of the knob increases the frequency.

If only the sine wave output is needed, it is possible to simplify and cheapen the instrument considerably. All the circuitry associated with TR5-TR8 can be eliminated, together with the discriminator diodes. The meter, metering circuit and switch can be dispensed with if the constructor is willing to accept the small change in amplitude with frequency. The oscillator can be powered by the batteries directly, neglecting the Zener diodes Z_1 and Z_2 . A calibrated dial would be used mounted on the slow-motion drive, a hole being cut in the front panel. Access to a signal generator will now be required, and if one calibration scale is to be used, close-tolerance components will be needed for C_1 - C_8 . If an oscillator is already available, it will be found that the circuit of TR5-TR7 forms an effective squarer in its own right.

Additional layout and wiring diagrams will be given next month, together with some suggestions for the use of the instrument in amplifier testing, and photographs of amplifier waveforms.

Voltage Stabilizer

THE range of voltage stabilizing and regulating equipment manufactured by Claude Lyons Ltd., Valley Works, Hoddesdon, Herts, has been extended by the introduction of the BTR-5 series of a.c. electronic voltage stabilizers. The circuit principles of the established BAVR series are retained, but distortion has been reduced and solid-state circuitry used. At a power factor of 1.0 the distortion is no greater than 6%, this is reduced to 2% by the use of a filter. (Filters are fitted in the BTR-5F models). The output voltage is adjustable from 200 to 254V. The input arrangement permits three selections by link adjustment, these are -15% to +5%, $\pm 10\%$ or -5% to +15% relative to the output voltage setting. The maximum output is 5 amps. The output stability is $\pm 0.3\%$ from zero to full load, this too, is improved in the BTR-5F version, the time constant is 0.1 second. The units can be supplied with or without filters and either rack or cabinet versions can be obtained. Overall dimensions and prices vary with the version required. The whole unit including terminal access and input range selector is enclosed in a metal case.

2WW 321 for further details.

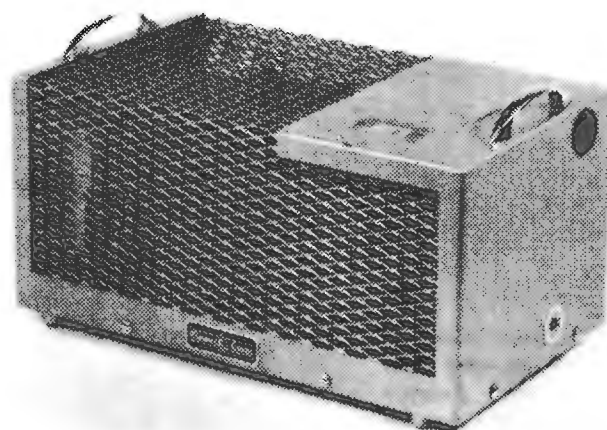

Claude Lyons voltage stabilizer Type BTR-5.

A forty-page quick reference guide to **Mullard Components** is now available from the Components Division of Mullard Ltd., Mullard House, Torrington Place, London, W.C.1.
2WW 302 for further details.

Ferralon Plastics.—W. W. Chamberlin (Associated Companies) Ltd., of Sartoris Road, Rushden, Northants, have issued a loose-leaf catalogue illustrating the plastic covering materials they manufacture for the radio industry. Some 300 finishes with several types of backing are available, and a representative selection of actual samples appear in the catalogue.
2WW 303 for further details.

Television downlead cables are described in a recent leaflet from British Insulated Callender's Cables Ltd. Technical details including constructional data and curves showing levels of attenuation, in dB's per 100ft, through Bands 1 to V are included. Copies of this publication are obtainable from 21 Bloomsbury Street, London, W.C.1.
2WW 304 for further details.

A brochure describing the transistorized American Daystrom "**non-contact**" **wire gauge** is available from Daystrom Ltd., Bristol Road, Gloucester. This instrument can handle products with diameters within the range of 0.001 to 0.750in, ± 0.0001 in.
2WW 305 for further details.

American Valve Guide.—The Metropolitan Supply Co. of 443 Park Avenue South, New York 16, have sent us a price catalogue of the American valves and tubes they handle. Called "**Buyers Guide**" it includes some 3,000 types.
2WW 306 for further details.

Two **dual concentric loudspeakers** are described in a leaflet from Tannoy. Both speakers have a frequency response of 25 to 20,000 c/s and the larger of the two, the "Fifteen" has a power handling capacity of 50 watts. The other speaker, called the "Twelve", is rated at 30 watts. Copies of this leaflet are obtainable from Tannoy Products Ltd., West Norwood London, S.E.27.
2WW 307 for further details.

The microwave and electronic instrument division of Elliott Brothers (London) Ltd., have produced a catalogue on their **transistor curve tracer**. This instrument can generate the data necessary to trace and display the characteristic curves of semiconductor devices on any general purpose oscilloscope. Copies of this publication are available from Elstree Way, Borehamwood, Herts.
2WW 308 for further details.

Radio receivers, radiograms and tape recorders manufactured by the German organization Loewe Opta are described and illustrated in a 24-page brochure available from Highgate Acoustics, 71-73 Great Portland Street, London, W.1. The publication is in English.
2WW 309 for further details.

Aerialite Ltd. have revised their "**Aerials and Accessories**" wall chart to include their new range of "Golden Gain" u.h.f. aerials and accessories. Copies are available from their head office at Castle Works, Stalybridge, Cheshire.
2WW 310 for further details.

Decca Radar Ltd., Decca House, Albert Embankment, London, S.E.1, have just released a brochure on a range of manual and automatic (electro-mechanical) **waveguide switches** for use in microwave systems, laboratory measurements and test circuits. The outstanding characteristic of these switches is that their isolation is greater than 100 dB over the whole waveguide band.
2WW 311 for further details.

Publication AEP.25-7 from the Westinghouse Brake and Signal Company Ltd., 82 York Way, King's Cross, London, N.1, is of particular interest to designers and engineers requiring **encapsulated rectifier units** in bridge, centre-tap or voltage-doubler arrangements. Among those described are potted versions with current ratings from one to four amperes having voltage ratings up to 420V.
2WW 312 for further details.

A fixed station **v.h.f. radiotelephone** Type FM120 is described in a leaflet from Hudson Electronic Devices Ltd., of 4 Sydenham Hill, London, S.E.26. These single-channel equipments, which, to special order, can be modified for seven-channel operation, employ f.m. modulation and have minimum outputs of 50 watts (de-rated to 25W in the U.K.) throughout the frequency range 71-175 Mc/s. A technical specification is included.
2WW 313 for further details.

A leaflet describing a new **vacuum tweezer system** from the scientific division of the American Schueler & Company is now available from Schuco International London Ltd., 46 Ravensdale Avenue, London, N.12. The system is completely self-contained and the vacuum pencil tweezer, which has five different vacuum pick-up tips, operates from a 220-240V a.c. vacuum generator.
2WW 314 for further details.

Société Européenne des Semiconductors of 41 rue de L'Amiral-Mouchez, Paris have produced a 12-page catalogue, in English, covering their comprehensive range of silicon and germanium **semiconductor devices**. These are listed in tabular form and include construction, absolute maximum ratings and typical characteristic details. Separate sections are given for various types of transistors, diodes, rectifiers and microminiature logic blocks. They have also prepared an English wall chart for their diodes and rectifiers, and another for transistors.
2WW 315 for further details.

Literature describing the complete lines of standard products of the scientific quartz and metals division is available from General Technology Corporation, 3510 Torrance Boulevard, Torrance, California. Leaflet 7100 describes **standard quartz and pyrex accessories** used for diffusion, doping and heat treating operations in the semiconductor industry. The division's line of standard tungsten, molybdenum and tantalum filaments, used for dielectric coating, metalizing of plastics, etc. are described in leaflet 7200.
2WW 316 for further details.

A 576-page booklet listing and illustrating the products of **Precision Instrument Components**, which range from anti-backlash gears and ball-bearing to universal multi-ratio gear boxes and worm and wheel assemblies is now available in the sterling area from the manufacturing licencees and distributors Reliance Gear Company, of Almondbury, Huddersfield. Other things of interest, include instrument differentials with less than 10 minutes of arc lost motion, breadboard development parts, helical gear assemblies and servo gear boxes. The Reliance Gear Co., who already have an extensive range, have informed us that the American tie-up has increased their stock range by some 20,000 items.
2WW 317 for further details.

Plastiglide's comprehensive range of **swivelglides, plastic guides and ferrules** specially designed for the furniture and radio and television industries are listed in a new 80-page publication from Plastiglide Products Ltd. of 58 Birmingham Road, Stratford-upon-Avon.
2WW 318 for further details.

Imhofs have just issued a booklet describing their range of over **seventy standard handles**—many of which are listed for the first time. Full dimensional details are given, together with illustrations of each type of handle. Also listed in this booklet is a wide range of miscellaneous accessories including hinges, locks, catches, castors, etc. Copies of this publication are available from Alfred Imhof Ltd., Ashley Works, Cowley Mill Road, Uxbridge, Middx.
2WW 319 for further details.

The International Nickel Company (Mond) Ltd. have published a new leaflet entitled "**The properties of the platinum metals**." This gives the latest published data on the basic properties of the six metals in the group and covers the principal characteristics, which make platinum metals so important to industry. The other metals in the group—palladium, rhodium, ruthenium, iridium and osmium which possess individual characteristics—are also described in the publication. Copies are obtainable from the publicity department at 20 Albert Embankment, London, S.E.1.
2WW 320 for further details.

NEW LOW-NOISE TRANSISTOR CIRCUIT FOR ELECTROSTATIC MICROPHONES

By P. J. BAXANDALL, B.Sc.(Eng.)

Amplitude-modulated R.F. Bridge Method with Many Advantages

THE conventional way of using an electrostatic (or condenser) microphone is shown, in its simplest form, in Fig. 1. The resistance R is made so large that, even at low audio frequencies, insufficient current can flow into or out of the microphone capacitance C , during one audio cycle, to cause a significant alteration in the stored charge Q . Since $Q=CV$, it follows that if Q is kept constant, the voltage V across the capacitance must vary when acoustic pressure causes C to vary. With the values shown, the response will be 3 dB down at about 30 c/s. From the point of view of signal-to-noise ratio, however, it is advantageous to use an even higher value of

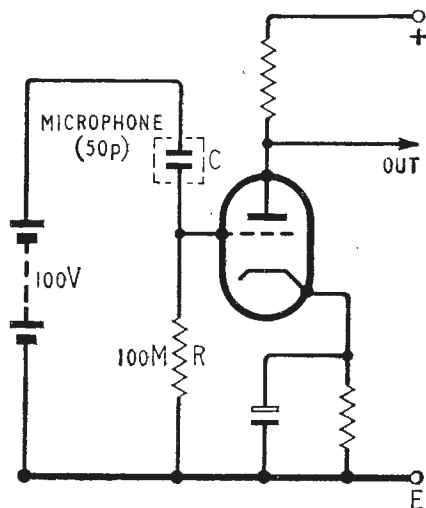

Fig. 1. Conventional electrostatic microphone circuit.

resistance than that dictated by the required low-frequency response.

When, in 1957, the writer first considered the problem of using an electrostatic microphone with purely transistor circuitry, it was quite obvious that the impedances involved in a circuit of the Fig. 1 type were far too high for it to be practicable simply to replace the valve by a transistor.*

However, by operating the electrostatic microphone element in a radio-frequency circuit, so that its capacitance variations are caused to modulate an r.f. carrier, the above-mentioned high impedances

are completely avoided and a very good performance can then be obtained with semiconductor circuits.

The general idea of using radio-frequency circuits for electrostatic microphones is, of course, quite old, and both frequency modulation and amplitude modulation have been employed.

F.m. systems have the disadvantage that random noise f.m. on the oscillator output inevitably gives rise to noise at the audio output terminals. Since the wanted f.m. is usually of quite small deviation, this noise f.m. can prevent the overall noise performance from being up to the highest professional standards.

In an a.m. system, however, by using a balanced bridge circuit, random noise modulation of the oscillator may be prevented from reaching the audio output terminals, and it was mainly for this reason that the author rejected f.m. systems right at the beginning and concentrated on a.m. bridge circuits—and if a bridge was to be used, then there was everything to be said for employing the transformer ratio arm principle first proposed by A. D. Blumlein.

R.F. Bridge Circuit

The broad outline of the system adopted is, then, to have a radio-frequency oscillator with a centre-tapped output winding, the microphone element and a capacitor of equal value being connected in series across this winding, forming a bridge network. An r.f. out-of-balance voltage is then obtained between the junction of the capacitances and the winding centre tap, of magnitude dependent on variations in the microphone capacitance with acoustic pressure. This amplitude-modulated r.f. voltage is subsequently demodulated to recover the wanted audio signal.

In the first experiments, the centre tap of the oscillator winding was earthed and the bridge output was tuned to parallel resonance by an inductor to earth from the junction of the capacitances. This output was fed straight to a diode detector, the bridge being set slightly out of balance to give some carrier output and thus ensure linear demodulation. Quite encouraging results were obtained, though it was found important to select the right type of diode if excessive detector-circuit noise was to be avoided. Ordinary point-contact diodes were hopelessly noisy, but G.E.C. EW78 silicon junction diodes (now obsolete) gave consistently good results (10 samples tried), the noise output then being only slightly above the thermal noise level.

It was soon realized, however, that by employing a proper phase-sensitive detector and operating the

* It is interesting to reflect, however, that the notion of transistorizing the Fig. 1 circuit now seems to be much more nearly a satisfactory practical proposition than it did in 1957. This is because some types of silicon planar transistor are now available which will operate satisfactorily, in very high impedance circuits, at collector currents of a small fraction of a microamp.

Whilst the signal-to-noise ratio obtainable when using such a transistor in the Fig. 1 type of circuit would probably be rather inferior to that given by a valve, there are signs that other amplifying devices may in due course become available which will overcome this limitation. One such device is the insulated-gate field effect transistor (ref. 1) and another is the insulator valve (ref. 2).

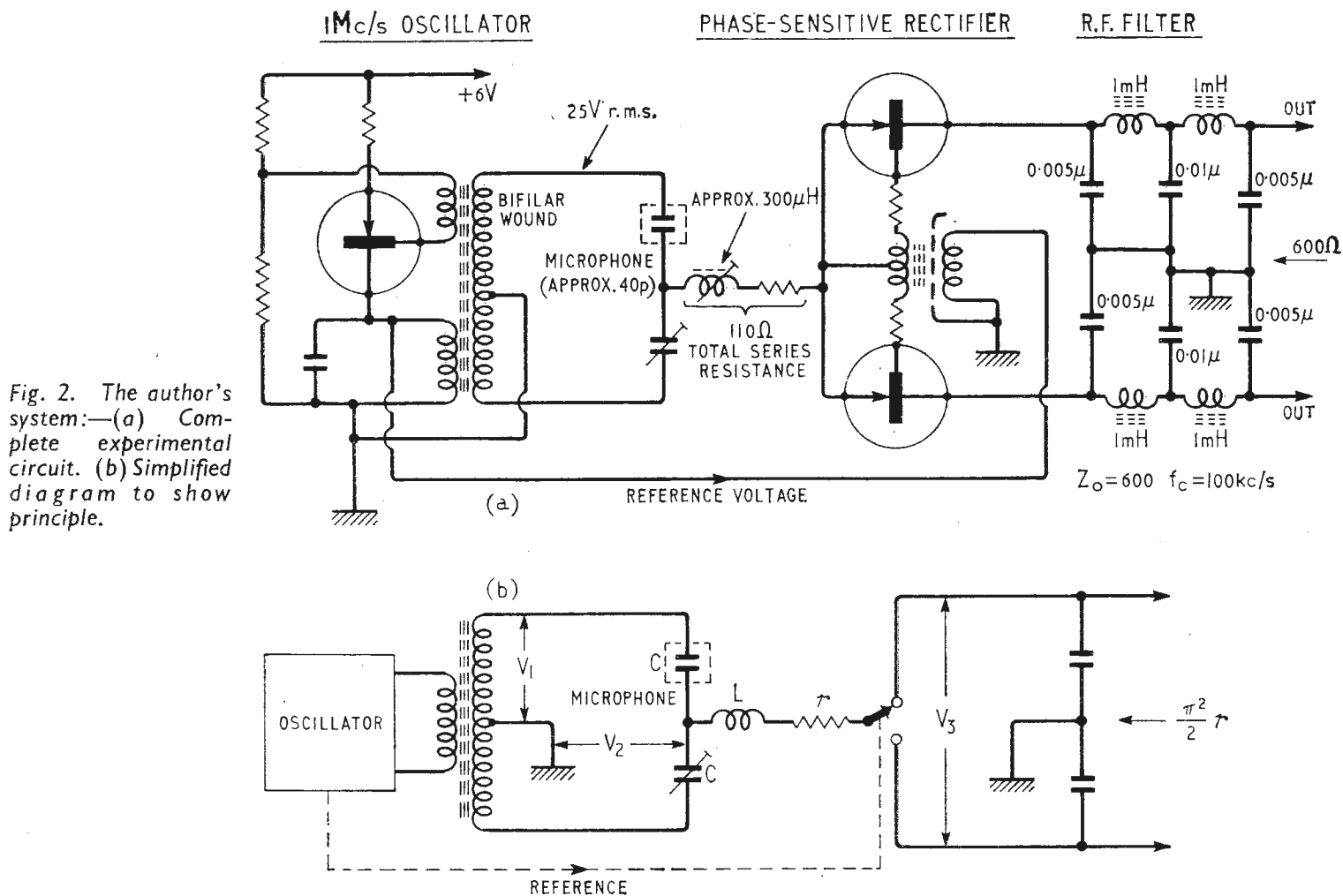

Fig. 2. The author's system:—(a) Complete experimental circuit. (b) Simplified diagram to show principle.

bridge in a nominally balanced state, larger long-term drifts in the bridge balance could be tolerated and the possibility of degradation of the noise performance by oscillator noise would be reduced.

It was further realized that by using series instead of shunt tuning of the bridge output, and by employing transistors as low-impedance switches in the phase-sensitive rectifier, the output impedance could be made low (e.g., 600 ohms), and balanced, without the need for an audio transformer in the microphone. Also it was expected that the noise performance would be excellent. For these reasons experiments on circuits using diode detectors were discontinued.

Fig. 2(a) shows the essential features of the circuit finally adopted. This circuit was first successfully demonstrated in July, 1959, and is the subject of British Patent Application No. 6118/61.

Starting at the left-hand side, there is a single-transistor 1-Mc/s oscillator. This circuit was chosen as being the simplest that would do the job. It takes about 5 mA at 6 volts, and operates in class B. By using class C operation, the efficiency could have been improved, but an extra capacitor would have been required in the emitter circuit—and one of the considerations is that every component saved is a help when it comes to building the circuit inside a small microphone casing.

The output winding of the oscillator is bifilar, so as to obtain very tight coupling between the two halves and thus to ensure that the voltages at the two ends will be very accurately in antiphase. The two halves of this winding form two arms of a bridge, the microphone and an air-dielectric trimmer forming the other two arms.

If the bridge is slightly unbalanced, owing to a change in microphone capacitance, a small 1 Mc/s

sine-wave voltage will appear at the junction of the capacitances, and will have a magnitude proportional to the change in microphone capacitance. The phase of the voltage will change by 180° as the bridge swings through the balanced condition. Thus, assuming the bridge to be perfectly balanced initially, the output waveform will be that of a suppressed carrier radio transmission when the microphone is acted upon by sound waves.

A very important point is that, looking back into the bridge output, the above modulated r.f. waveform comes from a source of quite low internal impedance, i.e., the reactance of the two capacitances in parallel, which is about 1,500 ohms—very different from the values of many megohms associated with conventional circuits.

Advantages of Tuning the Bridge Output:—By series tuning the bridge output by means of the inductor shown, the impedance seen looking into the right-hand terminal of the inductor is made even lower—Q times lower, in fact—but the bridge output e.m.f. is the same as before. Now, for a given e.m.f., the lower the internal impedance of the source of the e.m.f., the greater is the available power. The fact that in this system the tuned bridge, regarded as a source of modulated r.f. output signal, has such a low internal impedance, is the main reason for the excellent signal-to-noise ratio obtainable.

Of course, if there were no resistive losses, that is if the Q were infinite, the internal impedance of the tuned bridge would become zero, and infinite signal power would theoretically be available, at least for very slow changes in microphone capacitance.

In a practical microphone system the Q of the

series tuned circuit must not be made too high, otherwise the response of the system at high audio frequencies will be reduced, owing to sideband cutting, just as in a radio receiver. The resistor shown in series with the tuning inductor limits the Q to an appropriate value, in the region of 15.*

The rest of the circuit is concerned with the demodulating process, which is carried out by a simple phase-sensitive rectifier employing two junction transistors.

These transistors are used simply as on-off switches, which are operated by a reference voltage derived from the oscillator and fed in between their bases and emitters through the transformer shown. When a transistor is driven "on" at its base, it becomes capable of passing current in either direction between emitter and collector, or, in other words, it can function as a *bidirectional switch*. This is a great advantage possessed by transistors, as compared with valves.

Thus the two transistors, driven alternately into conduction by the 1 Mc/s reference voltage, per-

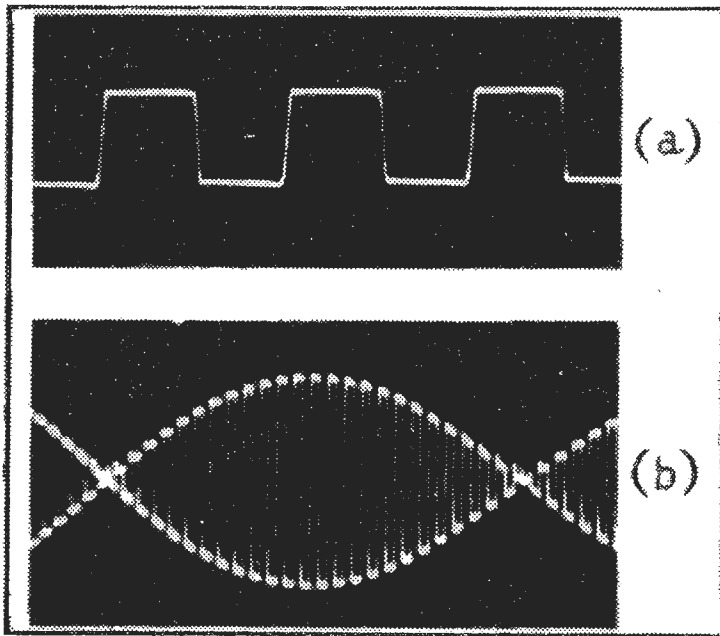

Fig. 3. Phase-sensitive-rectifier emitter-voltage waveforms:— (a) 1.5 V d.c. applied to output terminals. (b) 20 kc/s sine-wave voltage applied to output terminals.

form the same function as the two-way switch shown in the simplified diagram of Fig. 2(b).

Consider one instant of time at which current is flowing from left to right in the inductor of Fig. 2(b), the switch being supposed, at this instant, to be in the position shown. Then, while this condition holds, the tendency will be for the top plate of the top reservoir capacitor to be charged positively. During the next half cycle current will be flowing from right to left, but the switch will have changed over to the lower contact, so that the tendency will now be to charge the lower plate of the lower reservoir capacitor negatively, and so on.

* If the microphone amplifier input impedance is high compared with the output impedance of the microphone, then the resistor may be omitted without loss of h.f. response and with an improvement in signal-to-noise ratio. The d.c. input resistance of the amplifier is likely to be almost zero, however, owing to the input transformer, and if the damping resistor is omitted, a very small amount of unbalance of the bridge will give a large rectified current. For this reason it is considered better to retain the damping resistor even if an amplifier with a high a.c. input impedance is used.

Thus, all the time, the action of the circuit will be to tend to make the top output terminal positive with respect to the bottom one. It is easy to see that, if the bridge is unbalanced in the opposite direction, giving 180° difference in the phasing of the inductor current with respect to the operation of the switch, then the opposite polarity of d.c. output is produced.

Some Practical Points:—During most of the experimental work the circuit was exactly as shown in Fig. 2(a). No special arrangements were made for adjusting the phasing of the signal and reference in the phase-sensitive rectifier, though a slight phase adjustment is available by slightly detuning the series tuned circuit.

Later on, to improve the linearity of the demodulation process, the drive voltage to the base of each of the switching transistors was increased by about a factor of two, up to 3.5V r.m.s. This exceeds the base-to-emitter voltage rating of the transistors used, so two miniature point-contact diodes were added to prevent driving the bases too far positive. Small capacitors were shunted across the base resistors, now 4.7kΩ, to give a small reference-phase correction, thus allowing the series tuned circuit to be set exactly at series resonance. These measures improved the linearity at the expense of a small loss of signal-to-noise ratio. The measured results given later in this article were obtained with these modifications present, but the simpler arrangement is thought more appropriate for general use.

It may well be asked why the oscillator frequency was made 1 Mc/s, and several considerations were, in fact, involved. The frequency must be high enough to give a good noise performance and a conveniently low output impedance. A high frequency also makes r.f. filtering easier—the filter must have negligible attenuation at the highest audio frequency and 100 dB or so at the carrier frequency. On the other hand, the higher the carrier frequency the more difficult it becomes to get a really clean performance from the switching transistors. One has a natural bias towards round numbers and 1 Mc/s seems about as good a choice as can be made.

The procedure adopted for setting the circuit up correctly is the following. A 0.1 mA meter is connected across the phase-sensitive rectifier output, and the bridge is set slightly unbalanced to give a small reading on this meter. The slug of the series tuning inductor is then adjusted for a maximum milliammeter reading. Finally the bridge is balanced for zero reading.

Sensitivity of Microphone Circuit:—With reference to Fig. 2(b), the no-load r.f. output voltage of the bridge is given by:—

$$\hat{V}_2 = \frac{\hat{V}_1}{2} \times \frac{\delta C}{C} \dots \dots \dots (1)$$

where δC is the amount by which the microphone capacitance departs from its balanced value.

With no audio load on the final output terminals, no power can be supplied to the input of the phase-sensitive rectifier, since there is nowhere for it to go. Consequently V_3 must be such that the peak value of the fundamental component of the square wave on the switch is equal to \hat{V}_2 , thus giving zero

current in L and r . This leads to the result:—

$$V_3 = \frac{V_1\pi}{4} \times \frac{\delta C}{C} \dots \dots \dots (2)$$

In this equation V_3 may be regarded as the peak audio output e.m.f., δC being the peak value of the capacitance variation.

Audio Output Impedance:—It is interesting to consider what will be the audio output impedance seen looking back into the output terminals of the phase-sensitive rectifier. All we need to do is to determine how much direct current flows in the output leads as a result of applying a direct voltage, V_{dc} , to the output terminals. The ratio of the voltage to the current will be the output impedance, at low audio frequencies at least.

With V_{dc} between the two switch contacts (Fig. 2(b)), the waveform on the moving contact of the switch will be a square wave of peak-to-peak value V_{dc} . Owing to the selectivity of the r.f. tuned circuit, only the fundamental component of this square wave will be significant in causing r.f. current to flow in the tuned circuit, and the peak value of the fundamental component of a square wave is $4/\pi$ times the peak value of the square wave itself.

Thus we can calculate the current flowing in the series tuned circuit, and the power dissipated by it in the series loss resistance. This power must be supplied by the d.c. source connected to the output terminals, and there is nowhere else where the power supplied can be dissipated. Thus, by equating $V_{dc} I_{dc}$ to the power dissipated in the series loss resistance of the tuned circuit, we may find I_{dc} and hence the output impedance. Doing this in detail gives the result:—

$$[Z_{out}]_{LF} = \frac{\pi^2}{2} r \dots \dots \dots (3)$$

where $[Z_{out}]_{LF}$ is the output impedance at low audio frequencies and r is the total series loss resistance of the tuned circuit.

At higher audio frequencies things are more complicated, because the sidebands are then well separated from the frequency to which the tuned circuit is tuned (1 Mc/s), and the current in the tuned circuit is affected by its reactance as well as by the series loss resistance. Allowing for this, the total output impedance looks like a resistance of $\frac{1}{2} \pi^2 r$ in series with an inductance; the reactance of this inductance is equal to the resistance at an audio frequency equal to half the bandwidth of the tuned circuit. The inductive component is fairly

negligible, even at 15 kc/s, in the design adopted, owing to the low Q of the tuned circuit.

Provided sufficiently fast transistors are used in the phase-sensitive rectifier, the measured sensitivity and output impedance agree quite closely with the calculated values. Semiconductors Ltd. surface-barrier transistors, type SB240, were chosen. OC44s were used in the earliest experiments, and whereas these did produce results, the waveforms were far from the simple theoretical ones which would be produced by an ideal switch, and the output impedance was considerably lower than the calculated value.

The photographed waveforms shown in Fig. 3 show that quite fast switching action occurs. For these waveforms the tuned circuit was disconnected from the input terminal of the phase-sensitive rectifier and a high-speed oscilloscope was connected to this input point. The top waveform, a 1 Mc/s square wave, was obtained with a 1.5 V dry cell connected to the output terminals of the phase-sensitive rectifier. For the lower waveform, the dry cell was replaced by a 20kc/s sine wave from an oscillator.

Low-pass Filter:—Referring to Fig. 2(a) again, it will be seen that a low-pass filter is included between the phase-sensitive rectifier and the outgoing microphone line. This is to prevent r.f. currents getting out onto the microphone cable, and to prevent r.f. signals from elsewhere, picked up by the cable for example, getting back into the microphone circuits. This filter is very necessary, as otherwise objectionable heterodyne whistles could be generated under some conditions. The design of the filter is, however, very uncritical—it must have little effect on the audio-frequency response, but must have a very large attenuation at 1 Mc/s and above. The cut-off frequency has been made 100 kc/s, and no close-tolerance components are required. The attenuation at 1 Mc/s is about 100 dB, which is comfortably sufficient. The inductors were wound on $\frac{1}{2}$ in outside diameter ferrite toroids, and have so few turns that they can be quickly wound by hand, whilst the capacitors are small metallized paper ones, the maximum value being 0.01 μ F.

Constructional Aspects

For the experimental work on this system, the circuit was built in the manner shown in the accompanying photographs, no attempt being made to produce a compact layout. All the components

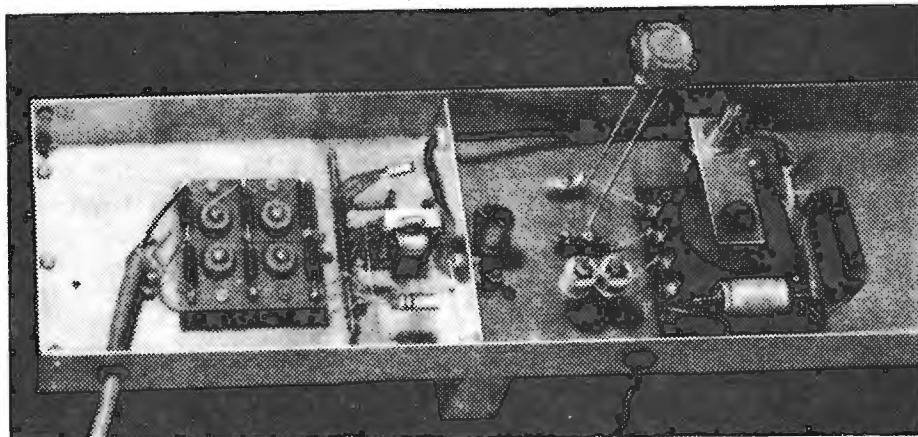
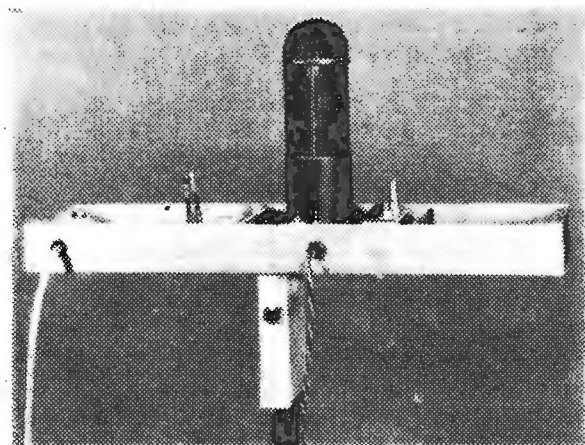

Two views of the microphone with its associated oscillator, phase-sensitive rectifier and r.f. filter.

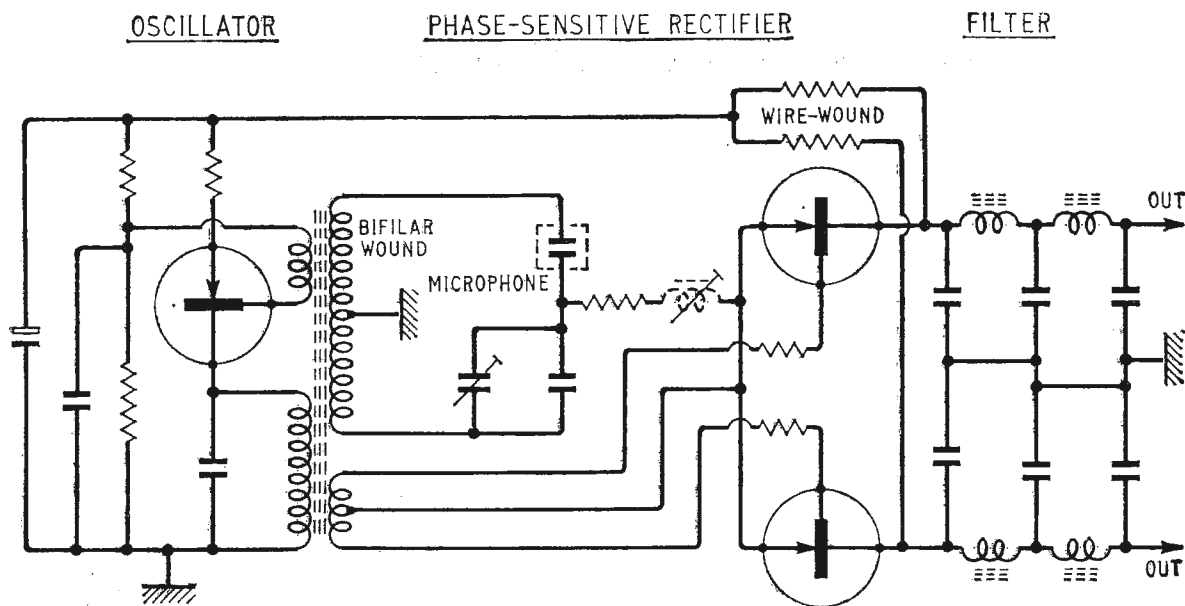
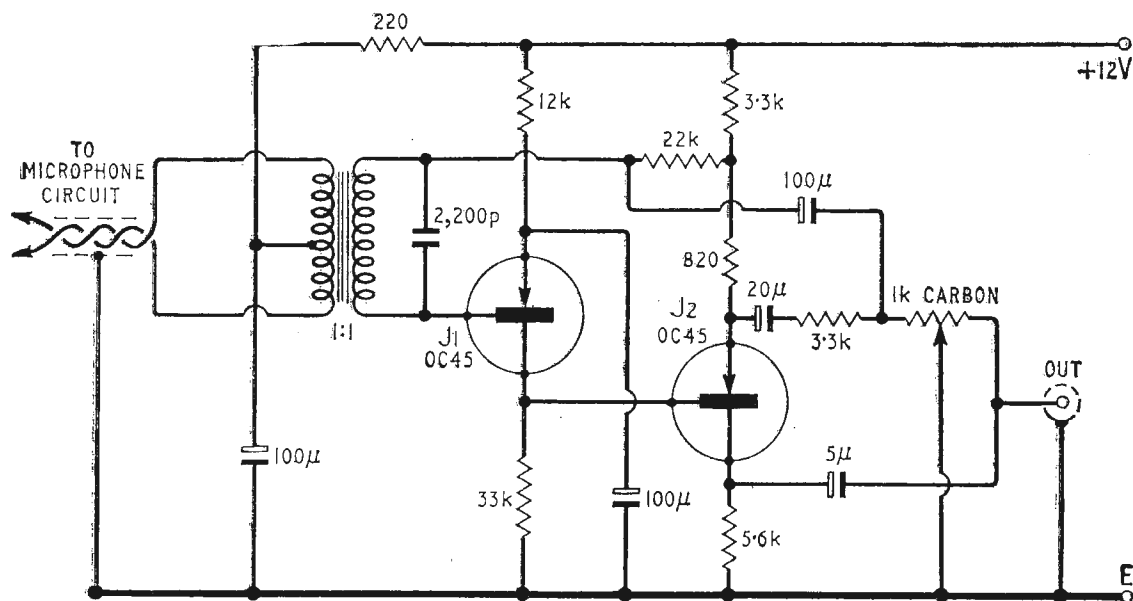

Fig. 4. Final microphone circuit.

Fig. 5. Microphone amplifier.



employed can be of very small physical size, however, thus permitting the final version to be built inside a microphone casing $\frac{3}{4}$ in diameter and 6 in long. The smallest size of Mullard "red series" Vinkor is very satisfactory for the oscillator coil.

D. C. Supply via Signal Cable:—In the early stages of the work, the d.c. supply for the oscillator was fed in along a separate pair of wires from those used for conveying the audio-frequency output—the wires may be seen in the photographs. More recently, however, the d.c. supply has been fed in along the audio frequency cable, the necessary arrangements for doing this being shown in Figs. 4 and 5, for the microphone circuit and the microphone amplifier circuit respectively. The amplifier is that described in reference (3), suitably modified to apply the required d.c. voltage to the incoming line. The amplifier will give an output of 10 mV r.m.s. for any input between 0.15 mV r.m.s. and 150 mV r.m.s., the harmonic distortion being under 0.2% throughout the whole of this 60 dB range.

With this scheme the only microphone cable required is an ordinary twisted and screened pair, such as might be used, say, with a moving-coil microphone—and it may be made up to at least 100 yards long if required with no appreciable difference in performance.

It will also be seen, in the Fig. 4 circuit, that the

separate transformer originally used for feeding the reference voltage to the phase-sensitive rectifier has been eliminated, an appropriate centre-tapped winding being added to the oscillator transformer.

(To be continued)

REFERENCES

1. "Nanowatt Logic Using Field-effect Metal-oxide Semiconductor Triodes" by F. M. Wanlass & C. T. Sah (Fairchild). 1963 International Solid-State Circuits Conference Digest, p. 32.
2. "Non conductor Valves" by "Cathode Ray." *Wireless World*, March 1963, p. 145.
3. "Low-distortion Amplifiers (Part 2)" by P. J. Baxandall, *Journal of the British Sound Recording Association*, Nov. 1961, p. 246.

"Wireless World Diary"

THE answers to 1,001 technical and general questions (from addresses of U.K. and overseas organizations to television standards and from u.h.f. television frequencies to valve and transistor connections) will be found in the 80-page reference section of the 1964 "Wireless World Diary". Now in its 46th year of publication the Diary—giving a week to an opening—is published by T. J. & J. Smith Ltd., and is available from newsagents and booksellers or direct from this office. It costs 5s 6d in rexine or 7s 6d in morocco leather, including purchase tax. Overseas prices are 4s 8d and 6s 5d and postage is 4d.

WESCON 1963—This Year's Electronics Exhibition in San Francisco

COLD statistics do little to convey the impact of the Western Electronic Show and Convention on a European visitor. In the rambling halls of the Cow Palace at San Francisco jostle 850 manufacturers of electronic equipment, occupying some 1,200 "booths"—a description which aptly conveys the rectangular, regimented units which make up the stands, markedly in contrast to the imaginative jumble of European shows. Over the four-day period of Wescon some 35,000 engineers, technicians and buyers passed through the Cow Palace, and at the twenty technical sessions over seventy-eight papers were read.

Wescon is a national exhibition, but due to its location at either San Francisco or Los Angeles is supported principally by West Coast manufacturers. As a result, the exhibition tends to reflect the West Coast preoccupation with the aerospace programme and its peripheral industries. Technically there are no startling advances to be reported from this year's Show, and the general mood appeared to be one of consolidation rather than spectacular gain. In answer to increasing competition many major manufacturers are diversifying into new product areas in an effort to keep up expansion rates. Texas Instruments for example stressed the output of its apparatus division and materials and control division at the expense of semiconductors, traditionally their strong line. They introduced their Model 659A semiconductor integrated circuit tester. This has a capacity of 36 tests on devices with up to 14 terminals with test times variable from 30msec up to 5 sec, making it possible to perform 36 tests in 1.5 sec. Also from Texas was an automatic transistor switching time test system, which will record switching time from 1nsec to 10 μ sec. This company also demonstrated their Model 2505 variable rise and fall time pulse generator, with repetition rates up to 25 Mc/s, pulse widths from 40nsec to 1 μ sec and rise/fall times from 20-500nsec.

Fairchild Semiconductors also showed an integrated circuit tester which tests both logic functions and input-output conditions on d.c. integrated circuits. Other Fairchild products shown included two semiconductor test systems, the Series 250 "go-no-go" multi-parameter tester and the Series 900 card-programmed data logger.

Hewlett-Packard showed increased diversification of not only instruments but also, via HP Associates, at Wescon for the first time, semiconductor products including step recovery diodes and fast switching diodes.

High-frequency Semiconductors:—Solid state devices for use in the microwave region will shortly be a reality, as semiconductor manufacturers become increasingly aware of the potentially large market in microwave equipment. V.h.f. transistors, varactors and tunnel diodes operating in the v.h.f.-u.h.f. range are now commonplace, and form the basis for a new family of devices. These will, according to some observers, eventually replace valves, ferrites and mechanical devices now used in radar and microwave communication systems.

Philco, for example, introduced a tunnel diode amplifier which is reported to provide a maximum noise figure of 4-5 dB and 18-20 dB of gain over bandwidths up to 20%. Current work at Philco includes microwave switching with diodes in the range 2,000 Mc/s to 20,000 Mc/s.

Motorola introduced an integrated circuit linear amplifier for r.f., i.f. and wideband applications from

d.c. to 300 Mc/s. This consists of a matched transistor pair interconnected with a diffused silicon bias resistor and a silicon oxide bypass capacitor.

Sylvania exhibited a series of p-i-n microwave switching diodes and a line of silicon epitaxial diodes for applications in the v.h.f.-u.h.f. region. Also on show was a diode switch with a turn-on time of 5nsec at 4,300 Mc/s.

Westinghouse were showing three new fast switching diodes and have a family of experimental high-frequency high-power devices at the laboratory stage.

Silicon planar transistors are now moving into the v.h.f. and u.h.f. bands. Powers of 10 to 30 watts were commonplace and the best of the v.h.f. power transistors with cut-offs of 100 to 700 Mc/s can produce around 6 dB gain at 100 to 200 Mc/s and oscillate up to 500 Mc/s. This order of performance seems to be achieved by variations on the "interdigitated" approach. In this technique, the emitter island is given a winding coastline to provide a large periphery, and in effect amounts to paralleling many high-speed geometry transistors. Thus the power-handling capability can be increased at no sacrifice to frequency response. Some of the manufacturers in this field were Bendix, Fairchild, Texas, Motorola and Clevite.

Microcircuitry:—These techniques formed a significant area in the semiconductor field, no fewer than 33 firms showing integrated circuits, not to mention the thin film exponents. Though techniques are advancing steadily here, low yield seems to plague silicon planar integrated circuits, most manufacturers considering a 10% yield better than average. General Electric were showing a simple reference amplifier series, RA1 to RA3, comprising two active elements, a transistor and a Zener diode. GE report superior temperature stability and economic advantages over conventional devices for this unit. Fairchild were showing their epitaxial micrologic elements designed for digital computer logic applications. These comprise, among others, buffer elements, flip-flops, gates, half-adder elements and half-shift registers. Fairchild claim that using a modified form of NOR logic, this family of elements permits the synthesis of all computer logic functions. Westinghouse (Molecular Electronics Division) were offering a custom-built integrated circuitry facility. This organization is capable of designing and fabricating "molecular" block functions using the customer's circuit as an analogue. Active equivalents available include diodes and field effect transistors using the silicon planar epitaxial technique. Signetics Corporation offered custom-built integrated circuits of a more limited nature in that customers could choose variations on a series of basic integrated circuit dice.

The thin-film solution to the microcircuit problem still has advantages over integrated circuitry in some applications and several firms were showing flip-flops and other logic elements.

Laser Techniques:—Lasers were well represented at Wescon, no fewer than 23 manufacturers showing their versions of these devices. The trend here is to make lasers commercially available (as distinct from laboratory devices), many firms quoting deliveries of 60 to 90 days. The RCA Lasecon (laser detector and converter) tube uses periodic permanent-magnet focusing and has a

semi-transparent photo cathode. Nominal frequency range (modulation) of the Lasecon with an L-band helix is from 1 to 2 Gc/s but, by using r.f. mixing, it can detect modulation from 0 to 4 Gc/s. RCA's GaAs laser, providing an emission wavelength of 8,400 angstroms, is also available. General Telephone and Electronics were showing their GaAs laser system. The type SL-6320 produces a coherent radiation at 8,450 angstroms when operated at 77°K. General Telephone and Electronics also had an interesting demonstration of laser communication possibilities. This was a system which achieved simultaneous transmission of two stereophonic radio channels over a single laser beam. Information is impressed on the carrier by duplex polarization of the light beam. The Perkin-Elmer Model 5200 gas laser is designed for both laboratory research and systems applications. Standard wavelength with the mirrors supplied is 6,328 angstroms, but it can also generate 1.15 or 3.39 microns. Light output of this device is polarized and in the fundamental mode the unit delivers 0.5 milliwatts. The Hughes Model 202 designed for experimental use in the laboratory or in industry, emits at 6,943 angstroms; total beam energy of 1 joule minimum, with 750 joules input and a nominal beam width of 10 milliradians. TRG Inc. reported that its Model 104 laser is being made commercially available. This pulsed ruby laser system is capable of outputs up to 3 joules at 6,943 angstroms.

Computers:—Though not catering specifically for the computer industry, Wescon attracted a representative selection of manufacturers in this field. The accent generally was on low cost general purpose computers with wide industrial as well as scientific applications. Digital Equipment Corporation for example had an interesting application for their PDP-5, said to be the most economical computer using a ferrite core memory. Allied to a pair of Nuclear Data analogue-to-digital converters, the PDP-5 was shown operating as an extremely flexible pulse height analyser. The usual disadvantages of a special-purpose analyser is inflexibility of its wired programme; the PDP-5 overcomes this to a large extent and has the additional advantage of being useful for a wide range of computation tasks when pulse height experiments are not being run. Having a memory cycle of 6 microseconds the PDP-5 can use some 3,800 of its 4,096 memory locations as channels and, since two A-to-D converters are used, multi-dimensional studies are quite feasible. Also from Digital Equipment Corporation, the PDP-4 was illustrated as an automatic checkout for digital modules. Shown with a Tektronix 567 oscilloscope, this computer was capable of performing an a.c. test such as rise-time, fall-time, pulse height, etc. in 100m sec, and a d.c. test in 50msec. A typical programme would run through 45 tests in less than 6 seconds. The LGP-30 computer, being shown by General Precision was oriented to the small organization, low volume application in business or engineering. Also having a memory of 4,096 words, the LGP-30 employs a magnetic-drum memory and has a minimum access time of 6msec. More ambitious, the Packard-Bell PB 440 computer has a memory capacity of 32,000 words and a 5µsec cycle time of its ferrite core memory. Among the peripheral devices available from Packard-Bell were their M20 and M21 analogue-to-digital converters. Having a pure binary or BCD output, the M21 is capable of 70,000 conversions a second with a conversion time of 1.2µsec.

Instruments:—Electronic test and measuring equipment formed a large part of the Show and here also the

mood was one of steady advance rather than startling innovation. Electro Scientific Instruments demonstrated a genuinely new range of instruments. Their new Model 120 Double Ratio Set was particularly impressive. Capable of 0.2 parts per million resistance comparison, this direct-reading double ratio bridge makes 1:1 or 10:1 resistance comparisons and eliminates lead and connection resistance errors by the use of the Wenner balance technique. The Model 701 capacitance measuring system features one part per million resolution (with direct readout in capacitance deviation) and an overall accuracy of 0.01%. The 242 resistance measuring system has been married to a punched tape data logging system giving an integrated systems capability with 0.01% accuracy. Mikros, a subsidiary of ESI, were showing for the first time their EM-20 electrostatic electron microscope. This has 10 to 40kV accelerating voltages, automatic vacuum system and built-in camera, as well as interchangeable lenses. Maximum resolution of this microscope is around 35 angstroms.

Atomic frequency standards have moved out of the research area into general engineering applications as demonstrated by Space Technology Laboratories. The products division of S.T.L. was showing its portable rubidium frequency standard Model 1000B. Having a short-term stability better than 1 part in 10^{11} and long-term stability 1.5 parts in 10^{11} , this unit obtains its stability by utilizing the atomic resonance of rubidium 87.

Tektronix showed a new addition to their oscilloscope range, the Model 647. Fully transistorized and meeting severe environmental specifications, it accepts plug-in pre-amplifiers which give it a bandwidth of z.f. to 50 Mc/s at 10 mV/cm, as well as sweep delay facilities. Hewlett-Packard's Model 140A is a versatile general purpose z.f. to 20 Mc/s oscilloscope accepting a wide variety of plug-in units in both axes. The Type 1415A plug-in unit was particularly interesting in providing pulse reflectometer facilities in the time domain. The Analab dual-trace storage oscilloscope uses a truly integrating storage tube as distinct from the bi-stable variety. The model 1220 will store images for several months and will store repetitive signals up to 100kc/s. The Singer-Metrics Panoramic SPA-12 spectrum analyser operates from 10 Mc/s to 64,000 Mc/s. Having sensitivities varying from -105 dBm at S band to -45 dBm at 64 Gc/s, the SPA-12 has a wide dynamic range, a precise 0-40 dB i.f. attenuator and a 5-inch c.r.t. The same firm was also showing a portable fully transistorized spectrum analyser. The TA-2 accepts plug-in modules and with the AR-1 unit has a frequency range of 20 c/s to 35,000 c/s; maximum sensitivity being 30µV full scale. E.H. Research showed a range of pulse generators including the new solid state Model 123. This pulser combines a maximum repetition rate of 20 Mc/s with rise-times of 5n sec and a 25-W average power pulse train. John Fluke, exponents of differential voltmeters, were demonstrating their new 831A Microvolt Potentiometer. Basically a Lindeck type potentiometer with built in null detector, the 831A extends the measurement capability of a differential voltmeter to 5µV full scale to an accuracy at $\pm 0.05\%$. Full scale ranges go from 5µV to 50mV and input impedance is infinite at null.

The Exact Electronics Type 200 is an interesting solution to the problem of waveform synthesis. With this instrument it is possible to build up a complex repetitive or transient waveform which is composed of 50 individual segments directly and independently controlled in amplitude, slope and time duration. A family of plug-in generators provides a selection of the controlling parameters for each increment.

D.L.

LETTERS TO THE EDITOR

The Editor does not necessarily endorse opinions expressed by his correspondent.

Transistor Cut-off Frequencies

THE purpose of this letter is to draw attention to some errors in the article under the above title in the September 1963 issue.

The significance of, and inter-relationship between the various cut-off frequencies has been discussed by a number of writers. Perhaps the most classical treatment is that of Hyde (ref. A). Some other relevant references are included in the review paper (ref. B) quoted below. This latter article, while not being a substitute for the accurate, formal treatments of Hyde and others, presents

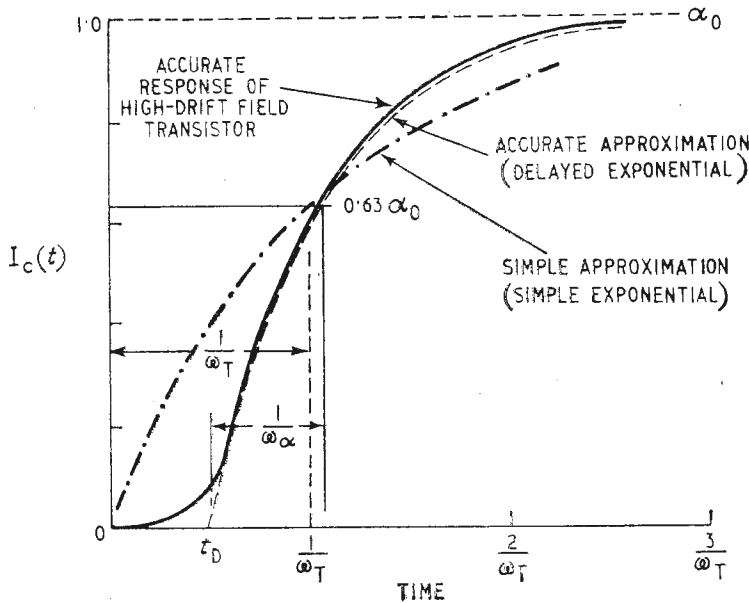

Fig. 1.

the following useful interpretation of the significance of the various cut-off frequencies.

For an ideal, intrinsic transistor, with or without a drift field, the collector current response to a unit step in emitter current has the general form shown by the heavy line in Fig. 1. This waveform may be determined, with difficulty, by analysis or, more easily, by direct measurements on an analogue. Experimental observations on actual, rather than ideal, transistors show similar collector current waveforms.

Subsequent mathematical manipulations may be simplified by the use of simple functional approximations to the time waveform:

An *accurate approximation* is to use the delayed exponential shown by the dashed line. This approximation is very accurate for times greater than t_D plus some small fraction of $1/\omega_\alpha$. The corresponding frequency variation of $\alpha(j\omega)$ includes the time delay as an excess phase term, viz.:

$$\alpha(j\omega) = \frac{\alpha_0}{1 + j\omega/\omega_\alpha} \exp(-j\omega t_D) \quad \dots \quad (1)$$

for all frequencies up to a few times ω_α . Obviously, from equation (1), ω_α as defined in the time waveform is identical with the α cut-off frequency as defined by Tilsley.

A *simple approximation* is to use the non-delayed exponential shown by the dotted line. This approximation may be written, for a unit step in emitter current, as

$$I_c(t) = \alpha_0 [1 - \exp(-\omega_T t)] \quad \dots \quad (2)$$

where ω_T has a value such that the total charge Q , which must be stored in the transistor to allow a given output current to flow, is the same for both the accurate and the approximate case (see Fig. 2).

It is but a short step to show that $1/\omega_T$ may be identified

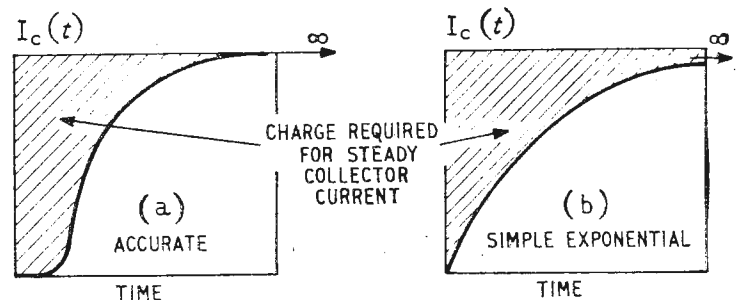

Fig. 2.

with the d.c. transit time, $Q/I_c(\infty)$, and that this approximation for $\alpha(j\omega)$,

$$\alpha(j\omega) = \frac{\alpha_0}{1 + j\omega/\omega_T} \quad \dots \quad (3)$$

can be given an RC significance in equivalent circuits.

Now, for an ideal transistor,

$$\beta(j\omega) = \frac{\alpha(j\omega)}{1 - \alpha(j\omega)} \quad \dots \quad (4)$$

and if either the accurate approximation for $\alpha(j\omega)$, eq. (1), or the simple approximation, eq. (3), is substituted into eq. (4), the magnitudes are identical in the vicinity of ω_β (the β cut-off frequency) and for a decade or more beyond ω_β (see Fig. 3).

Further insight into the relationship between ω_α and ω_T may be obtained from an accurate polar plot of $\alpha(j\omega)$. As shown in Fig. 4 ω_α is the frequency at which the $\alpha(j\omega)$ locus cuts the 3dB circle, whereas ω_T is the frequency at which the real part of the $\alpha(j\omega)$ locus is 0.5.

From these and other considerations the following detailed criticism of Tilsley's work emerges.

(1) f_α , f_1 and f_T are not "all virtually the same fre-

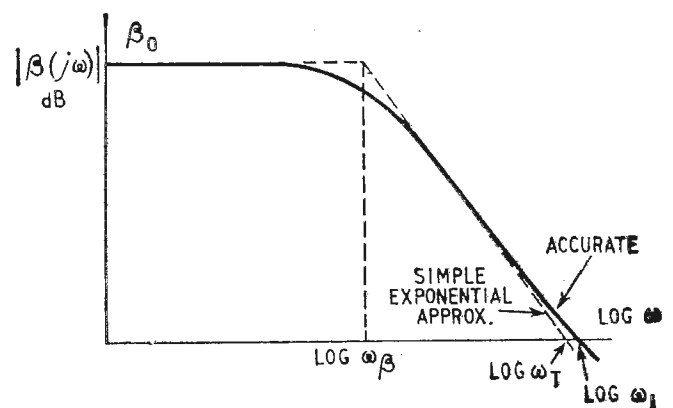

Fig. 3.

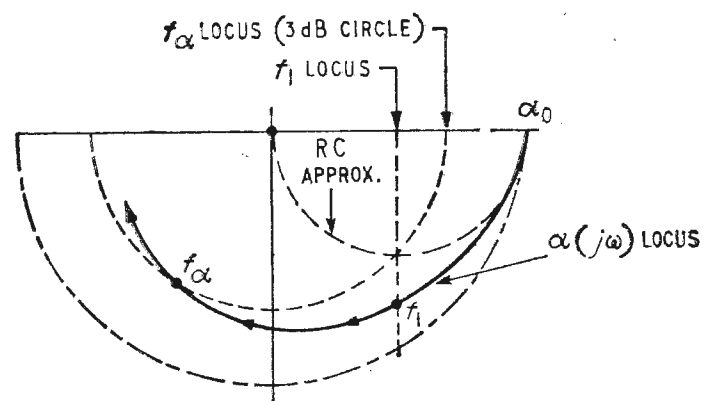

Fig. 4.

quency." The frequency f_α always exceeds f_1 ; the discrepancy is 22% for low-drift transistors and may reach 100% for high-drift-field transistors.

(2) f_β is related simply and directly to f_1 and not f_α , viz.

$$f_\beta = f_1/\beta_N$$

(3) The relationship (by eq. 4) between α and β involves vectors and Tilsley's calculation of a β magnitude of 2.3 when $|\alpha|$ is 0.7 is erroneous.

(4) The derivations given in the article are based on the simple RC approximation to $\alpha(j\omega)$ (shown by the dotted line in Fig. 4). It is certainly not valid to use this low-frequency approximation to establish relationships between high-frequency parameters. As an exercise in circuit theory, Tilsley's equation

$$f_1 = f_\alpha \sqrt{2\alpha_0 - 1}$$

is quite correct, but this circuit theory is applied to an inaccurate physical model and the result just cannot account for the observed differences between f_1 and f_α .

(5) It might be argued that the foregoing comments are somewhat academic, and that even a 100% discrepancy between f_1 and f_α is not large in comparison with the spread in cut-off frequencies for any given transistor type. However, from a purely applications viewpoint, Tilsley's misconception on the significance of f_β is of vital importance. While admitting that the gain-bandwidth product is f_1 (actually it is f_T), he suggests that the bandwidth of both common emitter and common collector stages is limited to f_β . This figure only holds for the completely unrealistic case of a current source feed; for practical wide-band amplifiers relatively low source impedances are used and the stage bandwidth is much greater than f_β and can approach $0.5f_T$.

(6) A final comment concerns the use of the symbols ω_T and ω_1 . In this letter I have adopted Tilsley's convention but my personal preference, and a convention adopted by some other writers, is to use $1/\omega_1$ as the transit time for an ideal transistor and $1/\omega_T$ as the transit time for an actual transistor.

Harwell, Berks.

D. E. HOOPER

Electronics Division, U.K.A.E.A.

References

(A) Hyde F., "The Current Gains of Diffusion and Drift Types of Junction Transistors." *Proc. I.E.E.*, Vol. 106, B Supplement, 17th March 1960, p. 1046.

(B) Hooper, D. E., and Turnbull, A. R. T., "Applications of the Charge-Control Concept to Transistor Characterization." *Proc. I.R.E. (Aust.)*, Vol. 23, March 1962, p. 132.

The author replies:

Other letters have been received, and in replying to Mr. Hooper, I hope that I am answering other correspondents.

The article was intended as an introduction to the difficult subject of the high-frequency behaviour of transistors and since it catered for readers unfamiliar with this subject, it is almost inevitable that those who have made a special study of this field would find it oversimplified and to that extent inaccurate.

(i) Perhaps the central point is my assertion that f_α , f_1 and f_T are all roughly the same frequency. If α is plotted as a complex quantity at different frequencies, then a curve of the form $\alpha = \alpha_0 \operatorname{sech} \sqrt{j\omega\tau_D}$ is obtained for the internal current gain, where α_0 is its low frequency value, and τ_D is the minority carrier diffusion time constant across the base region. This is shown in the diagram. In the article I was simplifying this to the dotted semicircle, and this is equivalent to taking only the first two terms of the expansion of $\operatorname{sech} \sqrt{j\omega\tau_D}$ in series

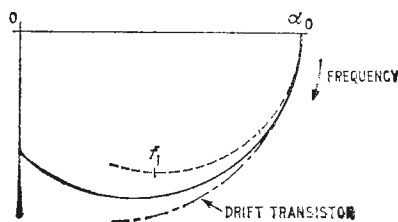

form. It is true that drift transistors deviate even further from the semicircle and perhaps I should have mentioned that then my approximation would be a very rough one. At normal frequencies of operation, and up to f_α , I maintain that this semicircular approximation is permissible as a first approach, and with this simplification f_α , f_1 and f_T are indeed identical. I consider that the more refined theory which gives $f_\alpha = 1.22 f_1$ more suitable for an advanced treatment, and for this Mr. Hooper's own paper in *Proc. I.R.E. of Australia* is excellent.

(ii) Since, in the approximation I have used, f_1 , f_α and f_α are taken as the same frequency, it is immaterial whether one writes $f_\beta = \frac{f_1}{\beta}$ or $f_\beta = \frac{f_\alpha}{\beta}$

(iii) In the f_β section of the main text of the article (as distinct from the "Derivations" section at the end), I purposely avoided any j terms which might not have been understood by all readers. My sole intention here was to show by using nothing more than simple arithmetic that β will fall off much more rapidly than α , and that it is not unreasonable for f_β to be about $\frac{f_\alpha}{\beta}$.

In the "Derivations" section, which I hoped would be read by those wishing a somewhat fuller treatment, I presupposed a knowledge of j and gave the correct proof. (But this, of course, also assuming a semicircular locus for α).

Mr. Hooper may consider this oversimplification to be wrong, but I hope he does not think that I didn't know any better!

(iv) The expression $f_1 = f_\alpha \sqrt{2\alpha_0 - 1}$ is also based on the semicircular locus, which Mr. Hooper considers to be founded on an inadequate physical model. Here again I must stress that I was reducing the subject to its very simplest terms consistent with obtaining useful results for those approaching the subject for the first time.

(v) Mr. Hooper is quite correct. I was considering the case of current-fed stages, which is a common assumption in elementary treatises. As he says, wide-band amplifiers fed from low source impedances can give much higher gain-bandwidth products.

I feel that the differences between the results obtained from the greatly simplified approach I adopted and those obtained from the fuller and more exact treatment Mr. Hooper proposes, are of importance only to those who already have a good understanding of this subject, and to whom the article would be quite superfluous anyway.

I would prefer readers to understand an approximate treatment than to be unable to follow a more exact one.

This one can find in any good text-book.

D. N. TILSLEY

Noise in Audio Amplifiers

I FEEL there are certain false approximations and surmises used by Mr. Tharma ("Noise in Audio Amplifiers," Sept. issue) which can influence some of his conclusions.

In order to obtain data on tape noise spectrum he has adapted curves given in his reference 2, which relate to measurements taken with full track system at a tape speed of 15 in/sec and equalized to N.A.B. standards, which he has merely bodily lowered by 10 dB in order to compare results with a $\frac{1}{4}$ track system at 3.75 in/sec.

First, the reduction in output e.m.f. produced by quartering the track width will be 12 dB (actually this will be more since $\frac{1}{4}$ track standard is less than this fraction of $\frac{1}{4}$ in tape) and not 10 dB as estimated. The reduction in tape speed has no effect on the head output e.m.f. for the same recorded low frequencies. From Tharma's reference 4 (page 193) the output e.m.f. of a magnetic head is given by:—

$$V = 4.44 \Phi f N \text{ (Volts)}$$

where Φ is the total useful flux; f = frequency and N the number of turns in the head windings.

Secondly, the reduction in tape speed will lower the pass band of the system and would thus alter the "character" of the noise spectrum. Fig. 8 and Fig. 10 show the

noise spectrum extending to beyond 15kc/s which is applicable to the original reference at the higher tape speed but can be considered to exceed normal performance at 3.75 in/sec.

Thirdly, the derivation of the head output e.m.f. for a 2H head by use of the expression $V_s = 3 \sqrt{L_s}$ mV at 1 kc/s, seems vague in the lack of including any known magnetic tape flux value. Reference is made to "full modulation on tape" but this has not been defined. If full modulation means a system in which all the parameters have been adjusted for maximum output (at the stated frequency) i.e. maximum sensitivity for a particular tape medium, then the figure of 4.2 mV for a 2H head seems unduly low.

Fourthly, the reference data on tape noise spectrum was originally subjected to N.A.B. equalization of 50 μ sec (turnover point 3.2 kc/s, where the ear is most sensitive) and cannot therefore be used to give a true comparison with a 3.75 in/sec system the equalization of which is normally 140 μ sec to 200 μ sec (1.3 kc/s—800 c/s).

Finally, the reference tape noise spectrum was obtained with a particular tape (Irish 211) which was subjected to a bias level corresponding to "peak output for a 1kc/s signal." The resulting data is therefore only applicable to "zero modulation noise" and it specifically excludes "modulation noise" which exists only in the presence of a signal and is a function of the instantaneous amplitude of the recorded signal. The data, therefore, cannot be used to arrive at a dynamic signal-to-noise ratio, but would be applicable for an assessment of a basic background tape noise during modulation pauses. If a "zero modulation" tape noise quantity is shown as a ratio of a signal at maximum recording level, a typical figure will be 60 dB. However, for the same medium a "modulation noise" ratio carried out to DIN 45 519, sheet 2, will indicate a "signal-to-modulation" noise ratio of only 35 dB.

London, N.W.7.

R. G. T. WARREN

The author replies:

Mr. Warren's comments are very interesting, but these do not affect our conclusions.

Inaccuracies of a few dB in the tape noise spectra are not significant as the noise spectra of the amplifiers are about 15dB below tape noise.

The differences between the spectra with AC107 and EF86 do not depend on the actual signal output from the head. So our conclusions are valid, irrespective of whatever heads or signal levels are chosen.

Obviously, as the amplifier noise is well below tape noise, it is also very much below modulation noise.

P. THARMA

Tape Guides

HAVING read with interest the recent correspondence on materials for tape guides, I'd like to suggest an explanation.

Although ideas in electrostatic forces have been introduced it seems probable that such forces would still be quite small compared with the simple mechanical friction, and it is thermal conductivity rather than electrical conductivity which may influence the result. Similar effects are well known to mechanical engineers in relation to bearing metals.

When tape is driven past a tape guide, work is done in overcoming the force of friction between the two materials. The work done is equal to the distance moved by the tape and the friction force opposing the motion. This work is converted into heat in the small areas of contact which rise in temperature until equilibrium is reached between heat generated and heat dissipated. Because the contact areas are small the temperature rise may be sufficient to melt the contact "peaks" on the tape guides. The corresponding area of tape involved is so much greater that heat is more

readily dissipated and melting is much less likely to occur and even more less likely to be detected.

This phenomenon of local melting, followed by adhesion and tearing is commonly observed in metal bearings which have been overloaded or underlubricated. The lubricant in well-designed bearings not only increases bearing support area and substitutes fluid friction for friction between solids, but also helps greatly to conduct the heat away without excessive temperatures. Lubricants are not easily applicable to tape guides. The high temperatures generated by rubbing solids is well known by the famous method of starting a fire by rubbing dry sticks together, dry sticks are poor thermal conductors.

If the above ideas apply, one would expect that the most suitable materials for tape guides would have a high melting point and preferably a high thermal conductivity as well as low coefficient of friction. The familiar highly polished, heavily chrome-plated metal guides satisfy this requirement well. Glass apparently succeeds, despite poor thermal conductivity, because of its high melting point compared with synthetic materials like p.t.f.e.

When local melting of tiny rubbing areas on tape guides takes place, irregular adhesion is likely to follow. the irregular dragging force in the tape would then be expected to cause elastic oscillations or flutter in the tape movement as has been observed.

London, N.W.10.

W. G. EALY

Electrostatic Attraction

BEFORE we spend time pondering upon the scientific implications of the tingling sensation experienced by Mr. Priestley (p. 501, Oct. issue), when he touched his wife's hand, could he please confirm that he was not on his honeymoon at the time?

Send, Surrey.

P. J. LEE

N.T.S.C. Colour

MAY I "rise to defend" the N.T.S.C. colour system, as used in my country for some years, especially to correct what I regard as a few misconceptions as expressed in the article in the September issue of W.W.? For one, the service problem: having recently had occasion to make a survey along these lines in connection with my own work, I can report that the unanimous opinion of dealers' service managers, and independent technicians, is that colour sets require "far less service than black-and-white"! (Direct quote from several.) This may be due in part to somewhat more careful construction, or closer quality control inspection, but it is a fact. My own experience verifies this.

As to assorted distortions and differential fadings, etc., I may hold the world's record for continuous long-distance colour TV reception; my best colour station is over 200 miles from my home in the Arkansas Hills. During more than eight years of every-day observation, I have had very little trouble with colour, *per se*; in fact, one of my favourite "prop stories" concerns the time when a signal faded completely out, leaving a Cheshire-cat-like bright red sweater worn by a lady as the only distinguishable object on the screen! Experimentally turning the colour off eliminated this, leaving nothing but snow! There have been difficulties, of course, but no more than in black and white, and very few of them attributable solely to colour. Colour transmissions have, in general, been of excellent quality, especially the live shows. There have been some difficulties on the taped shows, but the consensus of opinion among transmitter engineers seems to be that this is due mainly to inexperience on the part of network operators, and not to any basic faults in the equipment. Tape transmissions, as of now, are generally slightly inferior

in quality to live transmissions, but this can, and undoubtedly will, be remedied in the future.

I favour the inclusion of what we call "Color" (intensity of colour, or saturation of colour) and "Hue" (the actual "colour of the colour" or tint) controls, for customer operation. Just as brightness and contrast controls allow for an infinite range of adjustment on B/W pictures, from very pale to very dark, so do these controls allow the user to set up the picture to suit his own individual ideas! This, I should say, makes for better customer satisfaction with the whole idea. I've seen, in making service calls and demonstrations, how wide the range of "proper adjustment" can be! One will set up the screen with colours barely visible; another to what your author describes quite aptly as rude almost indecent health!

The only difficulty I've encountered, in actual field work, is of the type I ran into when setting up a colour TV for one married couple whose contentiousness was known far and wide. I set up the screen according to my own ideas. He promptly said, "It's too blue"; she replied, "No, too green!" So I tried to find a compromise setting. No luck. Finally, in desperation, I showed them both how to work the colour controls, and said quietly, "There it is—from now on you can set it up to suit yourself!" and disappeared into the wood-work! So they argued happily all that winter about whether the faces were bluish or greenish! This was not as bad as it sounds, as they had about run out of fresh subjects for argument anyhow, and they are now getting along better (outside of viewing hours) than ever before!

A final word as to cost. From what I have seen of the prices, we can expect to see colour TV sets ranging from \$400.00 upwards. Most manufacturers use the same chassis in all models, the sole difference being the cabinetry used. Motorola is in production on the new 90-degree rectangular colour picture tube, using a modification of a previous chassis aside from the special circuitry required to attain good convergence in the corners; most others use the original R.C.A. shadow-mask tube. As far as I can gather, aside from these, there are no plans to produce in commercial quantities any types of colour sets other than these two. Set-makers are still busily conducting colour schools for servicemen, and these are well attended. Dealers are reporting greater colour sales than ever, and one large dealer actually had more colour TV sets on his sales floor than black and white!

Mena, Arkansas, U.S.A.

JACK DARR

Wireless Telegraphy in the Royal Navy

WHILE supporting the principal contention of "Free Grid" in your issue of April 1963 ("Unbiased," p. 203) that wireless telegraphy was used by the Royal Navy for several years before the first installation in a merchant ship, I feel that he tends to overstate his case when he claims "the R.N. was using wireless . . . in 1893." It is true that Sir Henry Jackson probably already had the idea of wireless telegraphy in 1893 (a good many people had); he was unable to put the idea into practice for at least two years.

My researches into this period are, as yet, not sufficiently complete to give an exact date to the first R.N. experiments, but we already know the year from Sir Henry's own statement: "In 1895, systematic experiments were commenced by me with a view to utilizing the effect of Hertzian waves on imperfect electrical contacts, for naval signalling purposes." (*Proc. Roy. Soc.*, Vol. 70A, p. 254: 1902.) This means that the first trials were about a year later than those of Lodge and roughly contemporary with those of Marconi.

Nevertheless, the Royal Navy was the pioneer of maritime radio, and not only on a basis of early experiment. The practical value of wireless telegraphy at sea was demonstrated as early as 1899, when Marconi sets were installed in three cruisers for the annual manoeuvres

(see G. Marconi "Wireless Telegraphy" *Nature*, Vol. 61, pp. 377-380: 1900). This is approximately two years before the first Marconi installation in a merchant vessel.

Scampton, Lincoln. ROWLAND F. POCOCK

Television in Hospitals

THE regulations governing the hiring of television receivers make special provision for the short-term needs of patients in private rooms. It would not be illegal for me to hire a television set for my wife, who will be in hospital for the next fortnight, although I may not hire one for myself for less than three months.

I am concerned, however, with the possible, not the permitted. One large hiring service will not consider contracts below three months, another quotes a minimum charge of £8. I have been urged to have a 625-line set, although it was admitted that I should then have to pay for an aerial. It is not certain whether a receiving licence would also be needed: if so, the total cost amounts to roughly £1 a day, even without the pleasure of watching Band IV test programmes.

Surgical cases are usually adequately identified: after all, the surgeon does not want them to disappear without paying his fee. Since even the Board of Trade has shown some consideration for hospital patients, could not the rental companies risk a few portable sets for the prudent sick who have insured themselves against the long wait for the public ward.

London, W.8.

THOMAS RODDAM

The arrangement to which Mr. Roddam refers is not inherent in the regulations, but is a concession granted at discretion to local dealers who must themselves apply to their regional office of the Board of Trade.—ED.

RADIO COMMUNICATIONS EXHIBITION

THIS year's International Radio Communications Exhibition, previously known as the Radio Hobbies Exhibition, which opens at the Seymour Hall, Seymour Place, London, W.1 on October 30th for four days, is the sixteenth in the series sponsored by the Radio Society of Great Britain. The show will be officially opened by F. C. McLean, B.B.C. Director of Engineering, at 12.0 on the first day.

The R.S.G.B. will be operating two stations at the show one using the Society's headquarters call GB3RS and the other using GB2VHF. The latter call has been granted by the Post Office especially for use at mobile rallies, etc. As this is the jubilee year of the Society a display of historic equipment is included.

As will be seen from the following list of exhibitors there are a number of "users"—both professional and amateur—as well as manufacturers and suppliers of equipment taking part.

A feature of the exhibition is the annual competitions for home constructed and commercial equipment. On the W.W. stand will be demonstrated some of the recently described pieces of equipment including the W.W. oscilloscope, stereo balancer and audio signal generator.

Admission to the show, which opens daily from 10.0-9.0, costs 3s.

Aveley Electric.
Amateur Radio Mobile
Society.
British Amateur Television
Club.
B.B.C.
Daystrom.
Electroniques (Felixstowe).
Enthoven Solders.
G.P.O. Engineering Dept.
Green & Davis.
Hammarlund.
J-Beam Aerials.
K.W. Electronics.
Minimitter Co.
Philpott's Metalworks.

R.S.G.B.
Ralfe Radio.
Roding Boys' Society (Radio
Group).
Royal Air Force.
Royal Navy.
Royal Signals—Special T.A.
Communications Regt.
Salford Electrical Instruments.
Selray Book Company.
Short Wave Magazine.
Stern-Clyne.
Webbs Radio.
Withers Electronics.
Wireless World.

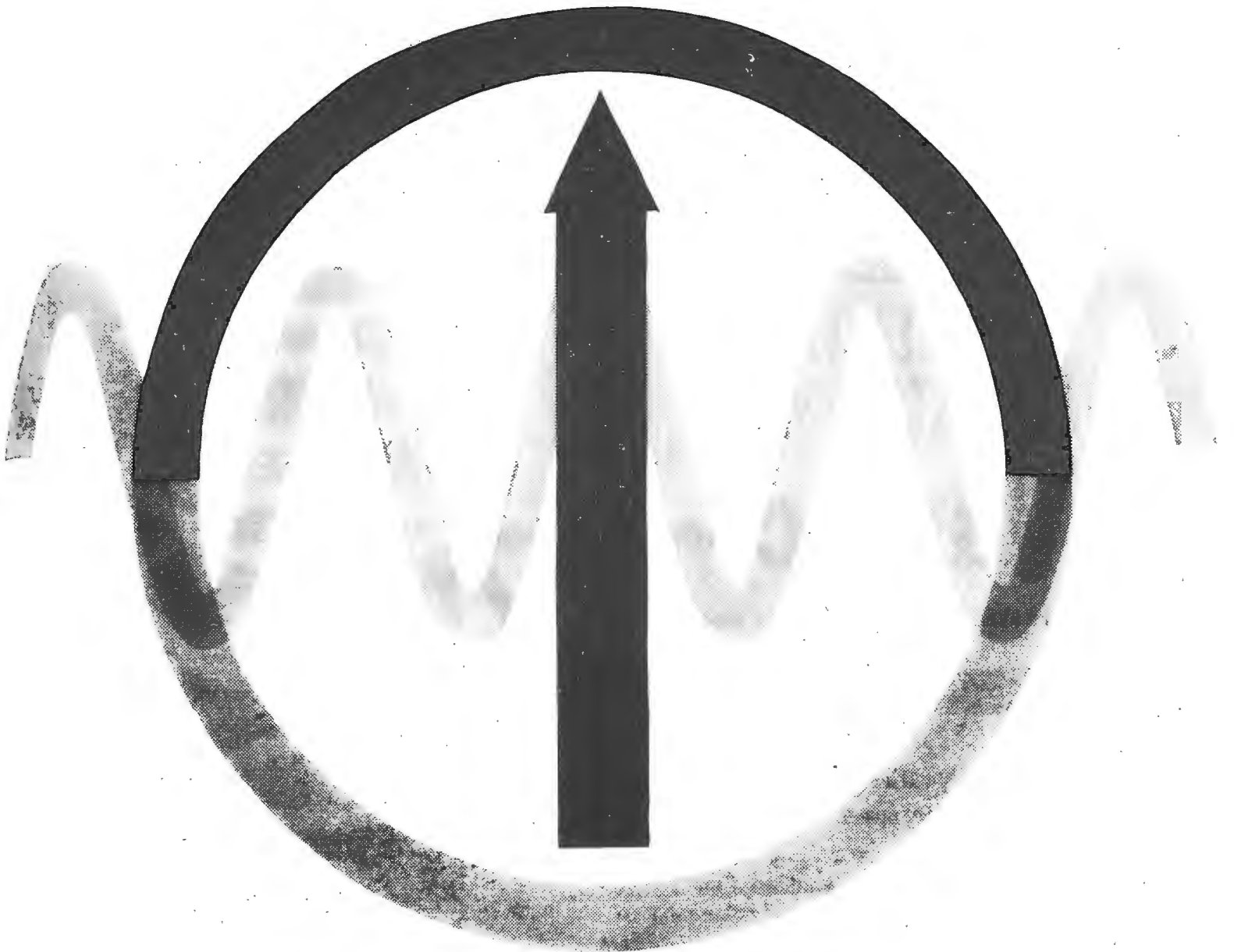

1 Mc/s to 320 Mc/s and constant output level

A highly stable signal from a constant impedance over the frequency range 1 Mc/s to 320 Mc/s is provided by the advanced design of the Airmec VHF Signal Generator Type 204. The facilities for modulation are comprehensive and the output may be either continuous wave, amplitude-modulated, frequency-modulated, pulse-modulated or combined amplitude- and frequency-modulated. The open-circuit output may be adjusted to any value from 2 μ V to 220 mV RMS and, being stabilised over the whole frequency range, there is no need for tedious checking and adjustment of the output. The VHF Signal Generator Type 204 is one of the complete range of VLF, LF, HF and VHF Signal Generators designed and manufactured by Airmec. This range is part of the comprehensive selection of high quality electronic instruments which Airmec produce for use in laboratories and workshops.

FREQUENCY RANGE:-
1-320 Mc/s in 5 ranges,
scale length 29 ft.

CRYSTAL CALIBRATION:-
0.05% calibration accuracy

ATTENUATORS:-
0-80 dB in 20 dB steps
0-20 dB in 2 dB steps
0-2 dB continuously
variable

STABILISED OUTPUT:-
2 μ V - 220 mV to RMS
from 52 or 75 ohms

CHECK DEVIATION:-
Enables deviation to be
checked against crystal and
provides fine tuning control

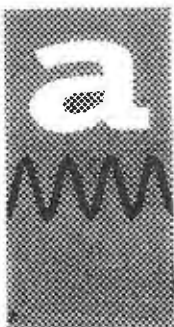
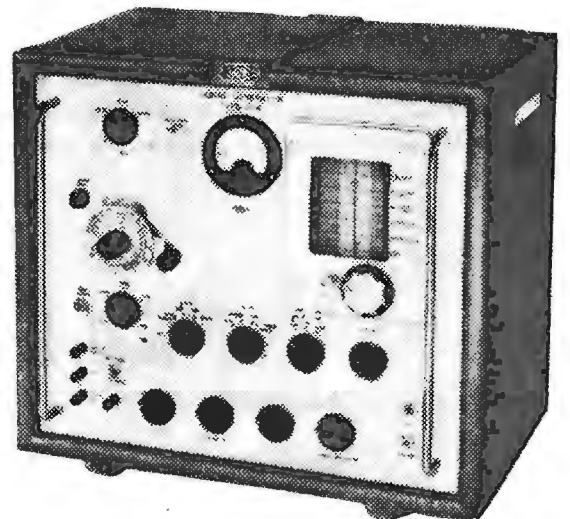

Airmec for peak performance consistently

The Airmec Range includes :- Signal Generators, Oscilloscopes, Wave Analysers, Valve Voltmeters, Ohmmeters and Phasemeters

LABORATORY INSTRUMENTS DIVISION
AIRMEC LIMITED, HIGH WYCOMBE BUCKINGHAMSHIRE ENGLAND
TELEPHONE: HIGH WYCOMBE 2501 (10 LINES)

2WW-110 FOR FURTHER DETAILS.

Wherever there is a need to vary AC voltage

YOU NEED THE
VERSATILITY OF

Variac^{REGISTERED}

THE ORIGINAL AND BEST VARIABLE TRANSFORMER

for infinitely variable control of voltage,
current, power, speed, heat or light

Variac* is the most useful device yet developed for the control of AC voltage. It provides a smooth continuous adjustment of output voltage, either manually or remotely controlled, from zero to line voltage and above.

Only Variac has Duratrak*—a patented track surface producing longer life, increased overload and surge capacity, and maximum economy in maintenance. The superiority of Variac has been proved in nearly 30 years of continuous service in factories and in laboratories throughout the world.

There are over 200 types of Variac, ranging from single small units for laboratory or instrument use to ganged assemblies for high power 3-phase operation. The range includes portable, open and covered, metal-clad and oil immersed types, dual-output and high-frequency types, plus many 'specials'.

Variac

* Registered Trade Mark

Variacs are made in England by
The Zenith Electric Co. Ltd., London
and exclusively distributed in the UK, Eire
and British Colonies by Claude Lyons Ltd.

Claude Lyons

Write for illustrated technical literature to Publicity Department, Hoddesdon.

CLAUDE LYONS LTD. Valley Works, Hoddesdon, Herts. Hoddesdon 4541 Telex: 22724

76 Old Hall Street, Liverpool, 3. MARitime 1761 Telex: 62181

2WW-111 FOR FURTHER DETAILS.

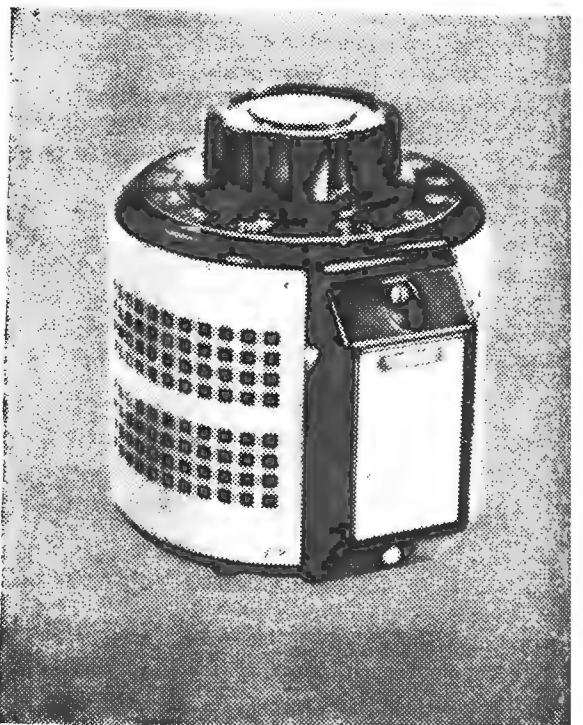

U.K.-Eire Section of I.E.E.E.

THE Institute of Electrical and Electronics Engineers, formed by the amalgamation of the American Institute of Electrical Engineers and the Institute of Radio Engineers, is a "non-national" society with interests in all parts of the world. The European Region 8 is regarded as being bounded by the Urals and the north coast of Africa and already includes sections in the Benelux countries, Egypt, France, Israel, Italy, Norway and Switzerland. The formation of a United Kingdom and Eire Section is now announced with headquarters at 2 Savoy Hill, London, W.C.2, where the I.E.E. has offered facilities for meetings, and office assistance. Officers of the new Section are Dr. R. C. G. Williams (chairman), Sir Harold Bishop and Sir John Hacking (vice-chairmen), Dr. R. L. Smith-Rose (treasurer), F. S. Barton (secretary) and R. C. Winton (assistant secretary/treasurer). Pending the establishment of an executive committee, an advisory committee drawn from the power and electronics sides of the profession will act on behalf of the I.E.E.E. Board of Directors. Its constitution is as follows: Dr. T. E. Allibone, Sir Edward Appleton, Sir Noel Ashbridge, Prof. H. E. M. Barlow, S. L. M. Barlow, F. S. Barton, P. A. T. Bevan, Sir Harold Bishop, C. O. Boyse, Dr. R. C. Cuffe, B. Donkin, Dr. P. Dunsheath, B. de Ferranti, Sir Archibald Gill, Sir John Hacking, D. P. Sayers, Dr. R. L. Smith-Rose, Dr. R. C. G. Williams (chairman) and A. J. Young.

Membership of the new Section is approximately 1,100. Total membership of the I.E.E.E. is 160,000 and of the I.E.E. 50,000.

Compatible S.S.B. Modulation

THE B.B.C. are to test compatible single sideband (c.s.s.b.) modulation equipment developed in the Eindhoven research laboratories of the Philips Group. If these laboratory tests prove satisfactory, the B.B.C. may apply to the P.M.G. to operate an experimental c.s.s.b. transmitter in the h.f. band.

This method of modulation, which basically, is an amplitude modulation system having the advantages of s.s.b., yet can be detected with a conventional envelope detector (as in a domestic receiver) without introducing distortion, has been known for a number of years. Probably the best known of the earlier systems, which have been developed for h.f. and m.f. applications, is that of Leonard R. Kahn and a paper by him titled "A compatible single sideband modulation system" appeared in the *Proceedings of the Radio Club of America* in March, 1958. The system the B.B.C. is to test, which has the same objectives as the Kahn system although it makes use of some different theoretical principles, is described in the paper "A method for obtaining compatible single sideband modulation" by van Kessel, Stumpers and Uyen in the February, 1962, issue of the *E.B.U. Review* (No. 71A).

The Netherlands radio authorities have already undertaken some experimental transmissions and it seems to be clear from these and other experiments that the system has several advantages over the conventional amplitude modulation systems. These include a better signal-to-noise ratio for an identical transmitter power (and will therefore increase the service area of the transmitter) and a reduction in adjacent channel interference (assuming the correct sidebands are chosen and the transmitters are strategically placed).

The results of the B.B.C.'s tests will be made available to the C.C.I.R.

COMPAC Complete

ON the 10th October the final splice in the 8,700-mile Commonwealth Pacific telephone cable (COMPAC) was made off Leeward, Oahu, one of the Hawaiian Islands in the Pacific. Extensive testing and "lining up" of the cable and the shore-based stations, which control the repeaters, is under way and the system is expected to come into operation early in December, linking Canada with New Zealand and Australia. This is the second phase in the U.K. to the Far East telephone link and, using the transatlantic cable CANTAT—which was commissioned in December 1961—and a new 3,000-mile microwave link spanning Canada, will provide 80 simultaneous telephone channels between the U.K. and Australia. London and Sydney telephone operators will be able to dial right through to subscribers at each end of the link and any of the 80 telephone channels can carry up to 22 telegraph circuits.

The cost of COMPAC, which has been jointly financed and organized by Britain, Canada, New Zealand and Australia has been put at £26,000,000. The third phase of the project is the laying of the South-east Asia Commonwealth cable (SEACOM), which will connect Singapore, Hong Kong, North Borneo and New Guinea to Australia and is scheduled for completion in 1966.

Modifications to Rugby GBR

TO improve the constancy of signals radiated by GBR (Rugby) at 16kc/s, modifications have recently been made to the aerial coupling circuit. Frequency is normally held to a few parts in 10^{10} but changes of aerial radiation impedance due to icing, low clouds and movement in high winds can cause not only 50% fluctuation of radiated power but also changes of phase, amounting to as much as $\pm 45^\circ$.

Formerly, long-period changes have been compensated manually by adjustment of a variometer forming part of the aerial inductance. Now the variometer is servo-controlled, the phase of the aerial current being compared with a reference derived from the output of the final amplifier. The new system is capable of responding to changes of tune during a single telegraph element of 20msec and with a residual phase error of less than $\pm 1^\circ$.

To complete the stabilization the main aerial tuning coils, wound with 6561/36 Litz cable on 16ft-diameter wooden spiders, have been stiffened to overcome phase jitter caused by electromechanical vibration at about 3 to 5c/s during on-off keying.

The overall performance is now such that the aerial current is constant to 0.1% and the phase relative to the crystal drive is generally within 0.5° with occasional excursions to 1° .

The station is widely used as a frequency standard and for comparison of time signals.

British Weeks in Europe.—The Export Council for Europe has announced that next year's "British Weeks" are to be held in Düsseldorf (23rd-31st May) and Copenhagen (25th Sept.-4th Oct.). Comprehensive handbooks have been prepared and are available from the Export Council for Europe, 21, Tothill Street, London, S.W.1.

B.C.A.C. changes to U.K.A.C.—At the annual general meeting of the British Conference on Automation and Computation Council held in London on 9th October, agreement was reached to adopt the new name of United Kingdom Automation Council. J. F. Coales, O.B.E., Reader in Engineering at Cambridge University, was elected chairman of the Council in succession to Sir Walter Puckey. A list of the 33 professional institutions—including the British Computer Society, the Brit.I.R.E., the I.E.E., the Inst. of Physics & Phys. Soc., and the Society of Instrument Technology—which constitute the membership of the Council may be obtained from the honorary secretary, F. Jervis Smith, c/o I.E.E., Savoy Place, London, W.C.2.

TV for Kuala Lumpur.—A Band III 625-line television service is scheduled to start in Kuala Lumpur, Malaya, next month. This is the second city in Malaya to have television, as a service was started in Singapore last April, and is part of the first phase of the Malaysian Television Service. Pye T.V.T. Ltd. supplied and installed the Kuala Lumpur 5kW transmitter and E.M.I. Electronics Ltd. have been awarded a contract to supply £100,000 worth of studio and o.b. equipment. The transmission and studio equipment for the Singapore service, which now operates on two Band III channels, was supplied by the Marconi Company (reported in the April issue). The associated o.b. equipment is Japanese.

African Communications.—The International Telecommunication Union (I.T.U.) has sent a small mission to Addis Ababa to assist in establishing the future telecommunications network of Africa. The aim of the mission is to bring about increased direct communication facilities between African countries. The I.T.U.'s assistance was requested by the Executive Secretary of the United Nations Economic Commission for Africa.

A.F.C.E.A.—The new president of the London Chapter of the American Armed Forces Communications-Electronics Association is Capt. J. R. Penfold of the U.S. Navy. As the membership of the Chapter includes many British electronics engineers several members of the executive committee are British. H. Schwartz (Decca) is 2nd vice-president, and Sir Reginald Payne-Gallwey (consultant), L. T. Hinton (S.T.C.) and W. C. J. Nixon (G.E.C.) are associate vice-presidents.

Apprenticeship Awards.—At the M-O Valve Company's apprentices' open evening (4th Oct.) completed indentures were presented and also two special awards for the year's best apprentices—M. A. Corden (electrical) and C. R. Maund (mechanical). In addition to craft apprenticeships, which now also include glass engineering, the firm offers technician and student apprenticeships, the latter leading to the Dip.Tech. in applied physics or electrical or mechanical engineering.

Schools Lectures.—Among the series of lectures at the Royal Institution for sixth form boys and girls from schools in the London area is one by Sir Lawrence Bragg on electricity and magnetism. It will be given at 5.30 on 5th November and repeated on the 6th, 12th and 13th. Prof. R. L. F. Boyd will lecture on the exploration of the upper atmosphere by space vehicles on 26th November and again on the 27th and December 3rd and 4th. Applications for tickets should be made to the Royal Institution, 21 Albemarle Street, London, W.1.

The Electronic Engineering Association has now issued Section 2 of its "Guide for joints on electronic equipment" dealing with "crimped joints for general purpose electronic cables." Copies of this guide are available from 11 Green Street, London, W.1.

Total attendance at the **Berlin Radio Exhibition**, which closed on 8th September, was 417,500. At the last exhibition in 1961 there were 387,500 visitors.

I.F.A.C. World Congress.—The International Federation of Automatic Control held its second world congress in the Swiss Industries Fair building in Basle, Switzerland, over the period 26th August-4th September. J. F. Coales, from Cambridge University, has been appointed the new president in succession to Professor E. Gerecke, who retired at the congress on the completion of his term of office. The next I.F.A.C. Congress is to be held in London in June, 1966.

U.H.F. Television Stations.—According to the latest edition (No. 8) of the list of European television stations issued annually by the European Broadcasting Union there are now about 150 u.h.f. television stations operating in Western Europe. Over 90 of the stations are in the Federal Republic of Germany and some 50 in Italy. The publication, which lists the stations in all four television bands, is obtainable from the E.B.U., Technical Centre, 32, avenue Albert Lancaster, Brussels, price 50 Belgian francs, and includes six bi-monthly supplements.

The end-of-the-year vacancies on the board of the **I.E.E. Electronics Division** are being filled by the following: P. A. T. Bevan (I.T.A.) and Prof. A. L. Cullen (Sheffield Univ.) as vice-chairmen, and Dr. R. L. Beurle (Nottingham Univ.), H. V. Beck (Marconi Inst.), W. J. Bray (G.P.O.), E. M. Hickin (G.E.C.), Dr. D. W. Hill (Royal College of Surgeons), J. Redmond (B.B.C.), Dr. K. F. Sander (Cambridge Univ.) and S. G. Young (G.P.O.), as ordinary members.

H.M.S. Leander is the first of several vessels of the Royal Navy to begin testing a new anti-submarine device known as **Variable Depth Sonar**. This device is towed behind the ship and can be lowered to considerable depths to enable a sonar beam to be transmitted below the reflecting temperature discontinuity layers which often impede the passage of sonar transmissions from hull-mounted apparatus. The equipment, which was developed in Canada by E.M.I.-Cossor Electronics Ltd., in conjunction with the Canadian Defence Research Establishment, has proved very successful in trials undertaken by the Royal Canadian Navy.

Another Anglo-American Link.—The transatlantic telephone cable TAT-3, linking Britain to the United States, came into service on 16th October, just five weeks after *C.S. Long Lines*, the American cable laying ship, left Southampton with 1,700 n.m. of S.T.C. cable to complete the American end of the project. Details of TAT-3 were given in the October issue, p. 502.

Band III B.B.C. Station.—The B.B.C. is to build a Band III television station at Winter Hill, Lancashire, to reinforce the existing Band I service from Holme Moss. Temporary arrangements are being made to enable transmissions, on Channel 12, to start at the beginning of next summer and the permanent installation—which, incidentally, will share the same site as the present I.T.A. station—should be completed in 1965.

The **Electrical Research Association**, of Cleeve Road, Leatherhead, Surrey, has issued a booklet "E.R.A. Electronics" to show more clearly what the Association is doing in the electronics field. It describes briefly the work being done on the electrical properties of thin films, on component reliability, etc.

The third **Industrial Photographic and Television Exhibition** opens at Earls Court on 11th November, for six days. It is open daily from 9.30 to 6.0 (4.0 on Saturday).

ILMAC 1966.—The third international exhibition and congress of laboratory, measurement and automation techniques in chemistry (ILMAC) will not be held until 1966. The dates are 17th-22nd October and the venue Basle.

NEWS FROM INDUSTRY

International Computers and Tabulators Ltd. have acquired the computer department of Ferranti for a consideration of £6.25M (1,900,000 fully paid shares and £1.5M in cash). The personnel of the Ferranti computer department, which total over 1,900, have been invited to join the I.C.T. organization. Basil Z. de Ferranti, M.P., who will remain a director of Ferranti, has been appointed deputy managing director of I.C.T. The digital systems department of Ferranti, at Bracknell and Oldham, which designs and manufactures digital and data-transmission equipment principally for military and other special applications, will not be transferred to I.C.T., nor will the industrial control systems department at Wythenshawe.

Electric and Musical Industries Ltd. have announced that their group profits for the year ended 30th June topped the £5M mark. Net profit amounted to £2,405,000 and showed an increase of £89,000 on the previous year's results. Incidentally, the directors said the electronics side of the business for the year had been very disappointing.

Net profit of **Telefunken G.m.b.H.** for the year ended 31st March amounted to £1,750,000 (DM 19,600,000) and represents an increase of £187,500 (DM 2,100,000) on the previous year's results. Sales compared with 1961/62 increased by 11% to £73,661,000 (DM 825,000,000).

Profits before taxation of **Decca Ltd.** and its subsidiary companies were slightly up this year (ended 31st March) at £2,958,000 as against £2,930,000 in the previous year. Net profits were, however, slightly lower at £1,444,000 as against £1,482,000 due to increased taxation.

Waveforms Limited, makers of the "Graph" range of oscilloscopes, has been acquired by the Metal Industries Group. The future activities of Waveforms are at present under review and for the time being all operations of the company will be conducted from the M.I. subsidiary Avo Ltd. of 92-96 Vauxhall Bridge Road, London, S.W.1.

Anglo-French Agreement.—The Marconi Company has signed an agreement with Compagnie Française Thomson-Houston to produce jointly a new secondary surveillance radar ground interrogator system. The equipment for this system, which is to be known as SECAR, uses transistors throughout, with the exception of the high-power output stage. Technical discussions between the two companies have been in progress since the end of last year and the main units are now in course of production.

£1M Orders a Month.—Sir Gordon Radley, chairman of English Electric-Leo Computers Ltd., has announced that his company has received orders at the rate of £1,000,000 a month since April this year when the company was formed, following the merger of Leo Computers Ltd. and the data processing division of English Electric.

A series of one-day exhibitions is being arranged by **Cossor Electronics Ltd.** to display their latest test gear, v.h.f. communications equipment, delay lines and other apparatus. The first two shows of the series are to be held at Queens Hotel, Manchester (13th November) and Grand Hotel, Bristol (26th November). Invitations may be obtained from the sales manager of the instrument division of Cossor Electronics Ltd., The Pinnacles, Harlow, Essex.

The **Solartron Electronic Group** have received an order to the value of £70,000 from the Air Ministry for six specialized direction-finding simulators. These simulators are to be used to train airfield controllers in the operational aspects of surveillance and secondary radar d.f. equipments. Solartron have also received an order from the Royal Navy for a "surface tactical and blind pilotage trainer," which has been designed to provide simulated radar information to several "model" ships simultaneously.

Standard Telephones and Cables Ltd. have been awarded a £200,000 contract for a new microwave telephone link between London and Bristol. The London terminal of the new link, which will operate in the 4,000Mc/s frequency band and provide 960 telephone circuits, will be the new Post Office radio tower.

Kelvin Hughes have installed one of their radar systems in the new British Railways ship *Avalon*. The complete installation comprises two independent, but switched, radar sets with 12in and 16in relative-motion or true-motion displays fitted in the ship's combined wheelhouse and chartroom plus an additional weather-proofed 12in relative-motion display on the flying bridge. Kelvin Hughes are also to supply twenty-five sets of radar equipment to Northern Trawlers Ltd.

The French Centre National d'Etudes Spatiales is to build **four satellite ground stations**. The control and tracking equipment for the stations, which will look like the American N.A.S.A. "Minitrack" centre, is to be supplied by C.S.F. (Compagnie Générale de Télégraphie Sans Fil), in conjunction with the electronics division of the aircraft engine company S.N.E.C.M.A. (Société Nationale d'Etude et de Construction de Moteurs d'Aviation), and C.F.T.H. (Compagnie Française Thomson-Houston).

Pye Ltd., in association with Technograph & Telegraph Ltd. (formerly Technograph Electronic Products Ltd.), have formed a new company, **Pye Printed Motors Ltd.** Its object is to manufacture permanent magnet servo motors, with printed circuit rotors, under licence from Société d'Electronique et d'Automatisme and Cie Electro-Mécanique of Paris.

To facilitate quick execution of orders from small electronics firms, maintenance departments, etc., **A. H. Hunt (Capacitors) Ltd.** have appointed a number of regional distributors. These are: Harper Robertson Electronics Ltd. (Glasgow); A. C. Farnell Ltd. (Leeds); Holiday & Hemmerdinger Ltd. (Manchester); Gothic Electrical Supplies Ltd. (Birmingham); Lugton & Co. Ltd. (London); Stewart Aeronautical Supply Co. Ltd. (Redhill); Wireless Electric Ltd. (Bristol). Bulk supplies will continue to be handled by the manufacturers.

Clyne Radio Ltd., Premier Radio, and Stern Radio Ltd., have amalgamated and are now trading under the name of **Stern-Clyne Ltd.** The company opened its seventh branch, at 26 Merchant Street, Bristol 1, on 12th October.

Television sales to retailers of the **Zenith Corporation** of Illinois topped the million mark in the first nine months of this year. This is the fifth successive year for Zenith to pass the million a year mark with television receivers.

The **English Electric Valve Co.** have appointed Max Paul Frey, of Berne, their exclusive agents for Switzerland.

The domestic range of radio and television receivers manufactured by **Bang & Olufsen** will in future be handled in this country by the Debendam electrical and radio division of St. Aldgate Warehouse Ltd., Innworth Lane, Gloucester. Aveley Electric Ltd., of South Ockenden, Essex, who have been handling some of these products, will continue to market the professional audio equipment of Bang & Olufsen.

Constructions Radioelectriques et Electroniques du Centre (C.R.C.) of France have appointed Claude Lyons Ltd., of 76 Old Hall Street, Liverpool 3 and Valley Works, Hoddesdon, Herts., exclusive agents in the U.K., Commonwealth, Republic of Ireland and South Africa for their precision electronic and nucleonic instruments, which include a.f. and v.l.f. generators.

The instruments division of **L.F.E. Incorporated** (Laboratory For Electronics), of Boston, U.S.A., who specialize in microwave test gear, have appointed James Scott (Electronic Engineering) Ltd., of Carntyne Industrial Estate, Glasgow, E.2, exclusive agents for the U.K.

Dentronics Incorporated, of Emerson, New Jersey, have appointed Coutant Electronics Ltd. sole U.K. agents for their range of strain gauges. Coutant Electronics are moving during the month from 711 Fulham Road, London, S.W.6 to 3 Trafford Road, Richfield Industrial Estate, Reading. (Tel.: Reading 55391).

Painton and Co. Ltd. of Kingsthorpe, Northampton, have signed a manufacturing and marketing agreement with the switch manufacturers **Donald P. Mossman, Inc.** of Brewster, New York. The agreement covers exclusive manufacturing-selling licences for the United Kingdom, the whole of Western Europe and Australasia.

Inspectron Ltd. of Empire House, Chiswick Road, London, W.4, have been appointed sole U.K. agents for **Sennheiser Electronics**, of Bissendorf, west Germany, who specialize in microphones and other audio equipment.

Dobbie McInnes (Electronics) Ltd., of 4 The Mount, Guildford, Surrey, have been appointed sole U.K. agents for the **Analac Company**, of Paris, whose products include a range of general purpose analogue computers.

Aros S.p.a., of Milan, manufacturers of constant voltage transformers, have appointed Langbourne Consultants Ltd., of Barnet House, 120 High Street, Edgware, Middlesex, exclusive U.K. agents.

Rank-Bush Murphy Ltd. have been allocated a 30,000 sq ft factory at Camborne, Cornwall, by the Board of Trade. Production of television sub-assemblies and components, to feed their Plymouth factory, is expected to begin at Camborne before the end of the year.

Cosmocord Ltd. have completed a 5,500 sq ft extension to their factory at Waltham Cross, Herts. The floor area of the complete factory now covers 55,000 sq ft and the extension, which is to be used by the plastics division, includes a large pressurized "clean room."

Farnell Instruments Ltd. are transferring their instrument agency and manufacturing business to a new 20,000 sq ft factory in Sandbeck Way, Wetherby, Yorks, at the end of the month. The telephone number will remain Wetherby 2691.

EXPORT NEWS

Ampex Great Britain Ltd. have received an order for about £250,000 worth of ferrite core memories from the **Swedish company** Standard Radio and Telefon AB, of Bromma. These components are to be used in a digital processing system which is being developed and manufactured for the Swedish government.

Norwegian Tours.—A new Kelvin Hughes demonstration van left the Hainault factory on 10th October to start a two-month tour of Norwegian seaports and fishing centres. This vehicle has been specially commissioned for demonstrations of marine navigational equipment and it is intended to follow up the present tour with similar tours in other European countries.

Federal Germany's Government Office for Weapons Technology and Procurement has signed a contract with Rank Cintel for the supply of four complete direction finding equipments for atmospheric together with accessories and spares. The present contract includes installation and is to be followed by a further contract for the development and supply of an automatic evaluation centre for atmospheric ranging. The total value of the contracts is in the region of £40,000.

As a result of a contract signed by Hifivox Production Barbieri of Paris and Garrard Engineering Ltd., some 65,000 Garrard record players and changers, to the value of over £160,000, are to be shipped to France during the next six months. Mr. A. E. Underwood, chairman of the company, has recently stated that his company exports over 70% of their total production, and during the past twelve months their overseas sales have risen by 42%.

Decca Radar Ltd. have received from the **Royal Swedish Air Force** £1,000,000 worth of orders for transistorized radar display and data handling equipment in the last eighteen months.

CLUB NEWS

Edgware.—Meetings of the Edgware and District Radio Society are held on the second and fourth Mondays of each month at 7.30 at the John Keble Hall, Church Close, Deans Lane. At the meeting on 11th November R. F. Stevens (G2BVN) will discuss single sideband operation.

Mansfield.—Morse and technical instruction are given at the weekly meetings of the Mansfield Amateur Radio Society held on Friday evenings at the Hope and Anchor Inn, Union Street.

Spen Valley.—"The Electronic Marshalling Yard" is the title of the talk to be given by S. Jones of British Railways at the 14th November meeting of the Spen Valley Amateur Radio Society. On the 28th J. Spivey (G2HHV) will discuss "office electronics." Meetings are held at 7.15 at the Heckmondwike Grammar School.



The display of the Dorking & District Radio Society on their stand at the four-day Model Railways & Engineering Exhibition held in Dorking in October.

PERSONALITIES

J. Langham Thompson is to be president of the British Institution of Radio Engineers in succession to **Earl Mountbatten**. Mr. Thompson, who is 57, has been a vice-president of the Institution for a number of years. He started his career with A. C. Cossor Ltd. in 1927 and seven years later joined McMichael Radio as chief engineer, where he remained until the outbreak of war. During the early part of the war he



served as officer i/c of the wireless section of the Inspectorate of Electrical and Mechanical Engineering and before forming his own company in 1946 he practised as a consulting engineer. Mr. Thompson last year relinquished the chairmanship and managing directorship of J. Langham Thompson and resigned from the board of Ether Langham Thompson. He is to deliver his presidential address on 27th November.

J. E. Rhys-Jones, M.B.E., M.I.E.E., has retired from the Plessey organization which he joined in 1933. Mr. Rhys-Jones, who is 62, has been concerned for the past 24 years with the setting up of small engineering units (remote from the main factories) for advanced development work. It was for his work on direction finding and navigation during the war that he was appointed an M.B.E. in 1946 when he was chief engineer of Plessey's communication receiver development. After studying at the Northampton Engineering College he started his career in the radio and electronics industry by joining S.T.C. at Colindale. He was also on the staffs of Marconiphone, Columbia Graphophone, H.M.V. and Kolster Brandes before joining Plessey.

John Garland retired last month after completing 47 years' service with the Marconi International Marine Company. Mr. Garland, who has been company relations manager for the past year, started his career as a seagoing radio officer in 1916. After representing Marconi Marine on many occasions overseas and founding Establecimientos Argentinos Marconi in Buenos Aires in 1935, he became general manager of the Marconi Group of Companies in South America at the end of the war. Four years later, he returned to the U.K. to become manager of the special products division of Marconi Marine; a position he held up to 1962.

Eric Willis-Jones, B.Sc.(Eng.), A.M.I.E.E., has been appointed commercial manager of A.E.I.'s valve and semiconductor factory at Lincoln in succession to **Dr. John Westhead**, who is at present on a course of business studies at Stanford University, California. Mr. Willis-Jones was previously based at A.E.I.'s London headquarters and held the post of manager, Southern Region Light Current.

A. E. Cawkell has relinquished his directorships of Cawkell Research & Electronics Ltd. and Dawe Instruments Ltd. and has joined Amplivox Ltd. as head of research and product development. After war service in the Communications Branch of the Royal Navy, Mr. Cawkell founded, in 1948, the company bearing his name which became part of the Simms group in 1960. Last year he contributed an article to *Wireless World* on the indexing of technical information.

Oliver Simpson, Ph.D., M.A., is to take up the post of superintendent of the basic physics division of the National Physical Laboratory next January. Dr. Simpson, who is 38, has been head of solid state physics at the Services Electronics Research Laboratory, Baldock, since 1956. After graduating from Trinity College, Cambridge, in 1944, he spent a year with the Admiralty Research Laboratory before returning to Cambridge to do research on photo-conductivity in semiconductors at the Cavendish Laboratory, first as a research scholar and later as Fellow of Trinity College. In 1949 Dr. Simpson was appointed an assistant professor of physics at the University of Michigan. At the S.E.R.L. he has been concerned with research on the electronic properties of organic semiconductors.

Dr. H. E. M. Barlow, F.R.S., Pender Professor of Electrical Engineering at University College, London, has been elected to the board of directors of Marconi Instruments Ltd. Professor Barlow, who is known for his work in the microwave field and in power measurement joined the faculty of engineering at University College, London, in 1925 and, apart from war service, he has been a member of the academic staff ever since. At the end of the war he rejoined University College as professor of electrical engineering and, a year later, he was awarded a fellowship. In 1949 he was appointed Dean of the engineering faculty. He is also a member of the B.B.C.'s scientific advisory committee and the Radio Research Board of the D.S.I.R.

L. A. Thomas, B.Sc., F.Inst.P., A.M.I.E.E., chief physicist of the Hirst Research Laboratory of the General Electric Company, and **Denis Taylor**, Ph.D., M.Sc., M.I.E.E., consultant to the Plessey Company, have just returned from the Soviet Union after visiting universities in Moscow and Leningrad. They were invited as members of a 15-strong delegation to see how the Russians co-ordinate their research efforts. The delegation, which was at the invitation of **V. Kuznetsov**, the director of the foreign relations department of the Soviet State Committee for the co-ordination of scientific research, was led by **R. J. Kerr-Muir**, the research director of Courtaulds.

D. Gabor, Dr. Ing., M.I.E.E., F.Inst.P., F.R.S., and **Colin Cherry**, D.Sc.(Eng.), A.M.I.E.E., have been granted Honorary Associateships of the City and Guilds of London Institute (A.C.G.I.) on the completion of five years as professors at the City and Guilds College. Dr. Gabor is professor of applied electron physics in the Department of Electrical Engineering where Dr. Cherry is professor of telecommunications.

Douglas Fowler, Assoc. I.E.E., has been appointed a director of Avo Ltd. Mr. Fowler came from Brookhirst Igranic, another subsidiary in the Metal Industries Group, to take up the appointment of Avo's works manager in 1961. After completing his apprenticeship with Brookhirst Igranic in 1932, he held several sales posts with the company and was subsequently appointed chief of organization and methods in 1957.

J. A. Avery, A.M.Brit.I.R.E., who has been chief inspector of Avo Ltd. since 1949, is to be chief engineer. Mr. Avery, who is 47, attained the rank of captain while serving with the R.E.M.E. during the war.

Douglas A. Lyons, for more than 30 years director of the Trix organization and a prominent member in the councils of the audio side of the radio industry, has resigned the managing directorship of Trix Electronics Ltd.

Gp. Capt. C. Stephen Betts, C.B.E., who is now Officer Commanding the Ballistic Missile Early Warning Station (BMEWS) at Fylingdales, was deputy director of operational requirements at the Air Ministry from 1959 until his new appointment earlier this year. Gp. Capt. Betts, who is 44, joined the Technical Branch of the R.A.F. in 1941 after graduating at Cambridge and was on signals duties with Coastal Command throughout the war. In 1952 he became Command Signals Officer, Air H.Q., Iraq, and three years later was attached to the Guided Weapons Dept. of R.A.E., Farnborough. In 1958 he was appointed chief instructor commanding the Weapons Systems Wing at the R.A.F. Technical College, Henlow, Beds.

The United States Navy Letter of Commendation has been awarded to **Wing Cdr. R. I. Gray** for his meritorious service whilst on an exchange posting during 1960/63 as a staff member of the electromagnetic hazards division of the U.S. Naval Weapons Laboratory at Dahlgren, Virginia. The award is in respect of three inventions to improve the safety and reliability of electrically initiated weapons. The inventions have been introduced to minimize the risks of premature initiation of the weapons' explosive systems by spurious r.f. radiation. Wing Cdr. Gray is now at the Central Servicing Development Establishment, R.A.F. Swanton Morley, Norfolk.

Among the recipients of monetary awards for inventions to save time and money in the Royal Air Force are two civilian radio technicians. **D. F. Willies**, who is stationed at R.A.F. Neatishead, Norfolk, received £50 for his idea which led to the modification of the power amplifier circuit in the Type T217A/GR multi-channel u.h.f. transmitters, to save valves being damaged while the transmitters were being tuned. Mr. Willies, who is an amateur transmitter with the call G3HRK, is the Norfolk county controller of the radio amateur emergency network. The other award, of £45, was made to **J. C. Wilson** of R.A.F. Wartling Sussex, for re-designing a section of the modulator drive stage in the Mullard radar training control equipment Type 2293.

A. H. Robinson, B.Sc.(Eng.), D.I.C., Grad. I.E.E., has been awarded the Oliver Lodge Scholarship by the Institute of Electrical Engineers to complete the final year in his investigations at Imperial College, London, into the possibilities for the bandwidth compression of video signals for transmission. He started this study in October 1961 under an award given by the Department of Scientific and Industrial Research.

Harry C. Roberts relinquished his position as managing director of the Cossor Valve Company, through ill health on 1st October, but he will continue in the capacity of a director and consultant. Mr. Roberts, who is 64, has been with the company since 1948 and was previously with Marconiphone and Mullard. He is succeeded by **S. D. Coode-Bate**, who was previously assistant to the managing director of Cossor Electronics Ltd.

G. S. Westbrook has been appointed group general manager by the Sealectro Corporation of Mamaroneck, U.S.A., and will be responsible for the British branch company at Hershams, Walton-on-Thames. Mr. Westbrook joined the Sealectro Corporation a short time ago after spending a number of years with Counting Instruments Ltd. in the capacity of director and general manager. Prior to this he held for six years a similar post with Electro Methods Ltd.

D. H. Fisher, A.M.I.E.E., the manager of the recently formed colour television division of R.C.A. Great Britain Ltd., has announced that **E. A. Neaf** has been appointed the division's sales manager. Mr. Neaf was previously with the closed circuit television division of the Marconi Company. **P. Scadeng, A.M.Brit.I.R.E.**, the division's engineering manager, joined the company in April this year from Rediffusion.

R. W. Sillars, B.A.(Cantab.), D.Ph.(Oxon), M.I.E.E., F.Inst.P., has been appointed manager of the A.E.I. Research Laboratory at Manchester. Dr. Sillars joined Metropolitan-Vickers (now part of A.E.I.) in 1932 and after two years as a college apprentice, he entered the research department. In the following year he went to New College, Oxford, as a Metro-Vick scholar and on his return in 1937 he re-entered the research department. Dr. Sillars' appointments include section leader of the semiconductor section in 1947, physics group leader in 1950 and leader of the electrical materials group in 1955.



Dr R. W. Sillars



Donald Scott

Donald Scott, Assoc.I.E.E., has been appointed engineer-in-chief of Cable and Wireless Ltd. in succession to the late **C. J. V. Lawson**, who died in August. Mr. Scott, who is 60 and joined Cable and Wireless in 1919, has served in a number of overseas stations. He was appointed assistant e.in-c. in 1955 and deputy e.in-c. in March last year. Four further appointments have been made following Mr. Scott's promotion. These are: **Anthony S. Pudner, M.B.E., A.M.Brit.I.R.E., A.M.I.E.E.**, and **Denis G. Smith** as deputy engineers-in-chief, and **William A. D. Talbot, A.M.I.E.E.**, and **Dudley W. Weedon, B.Sc.(Eng.), A.M.I.E.E.**, as assistant engineers-in-chief.

OBITUARY

Eric Balliol Moullin, M.A., Sc.D., Professor of Electrical Engineering at Cambridge University until 1960, died on 18th September, aged 70. Dr. Moullin, who was the first occupant of the chair of electrical engineering established in 1945 at the University, was a Fellow of both King's College, Cambridge, and Magdalen College, Oxford. He was a lecturer at Cambridge from 1920 until 1929 when he became Donald Pollock reader in engineering science at Oxford, where he stayed until being appointed to the professorship at Cambridge. His research studies covered a very wide range of radio subjects and his books include "Principles of Electromagnetism" and "Radio Aerials." Dr. Moullin, who was for many years on the Editorial Advisory Board of *Wireless Engineer*, was president of the I.E.E. for 1949/50.

Dr. Sisir K. Mitra, F.R.S., Professor Emeritus of the University of Calcutta, died in August at the age of 73. Prof. Mitra, who was elected a Fellow of the Royal Society in 1958 "for his researches in many branches of upper atmosphere physics," was professor of physics at the University for many years until his retirement in 1955. He was also head of the University's Institute of Radio Physics and Electronics. He received his D.Sc. from Calcutta University in 1919 after which he studied at the Sorbonne in Paris. Prof. Mitra was chairman of the Calcutta section of the Brit.I.R.E. for three years.

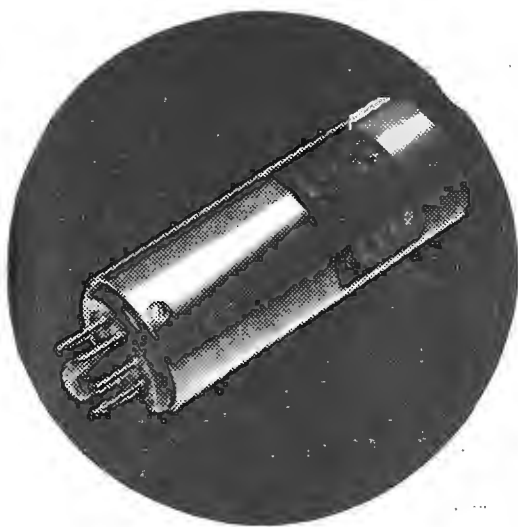

QUARTZ STABILITY

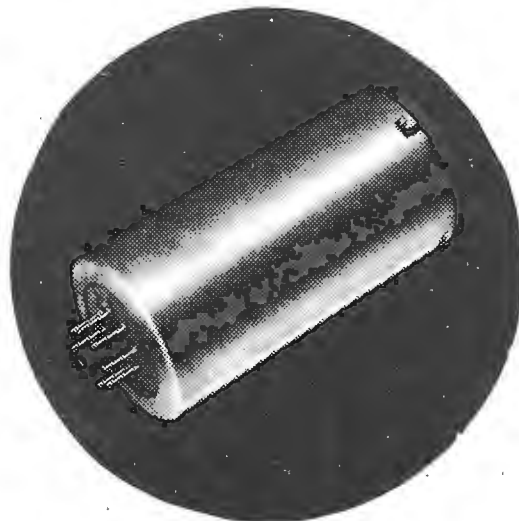
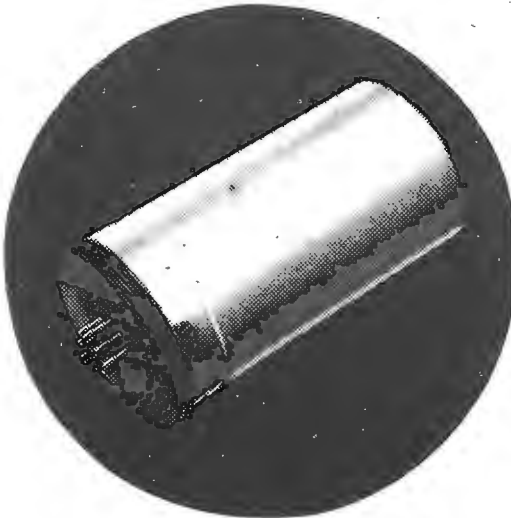
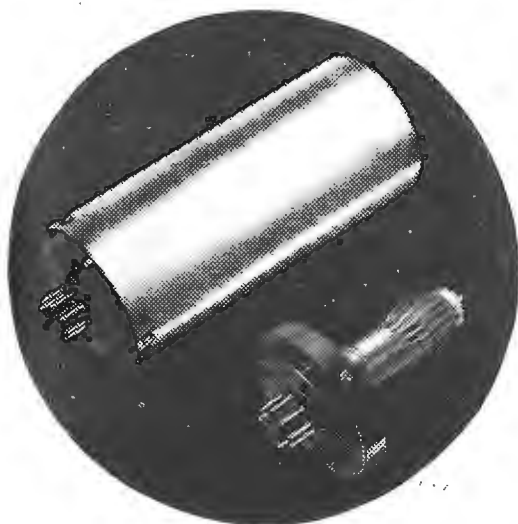

CRYSTAL OVENS

The Marconi 'change of state' oven employs no thermometer switch and has a switching differential of 0.0014°C.

Orthodox crystal ovens, using thermostats or thermometer switches, are available where wider temperature variations are acceptable.

CRYSTAL FILTERS

Standard crystal filters with SSB or bandpass characteristics are available for 100 kc/s operation, and I.F. filters for 455 kc/s. Many special filters are available for frequencies up to 20 Mc/s; and new designs can be produced to meet specific requirements.

The Specialized Components Catalogue lists over 110 Marconi Components, the design and manufacture of which is undertaken only when no suitable alternative is available, and in almost every case Marconi components are designed for higher performance and are made to closer tolerance than any available alternative.

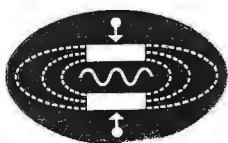
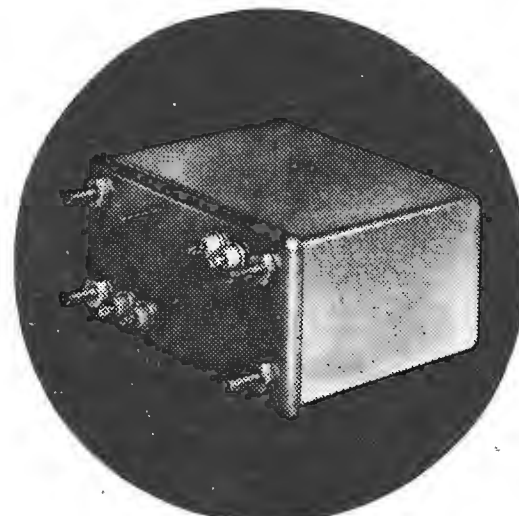
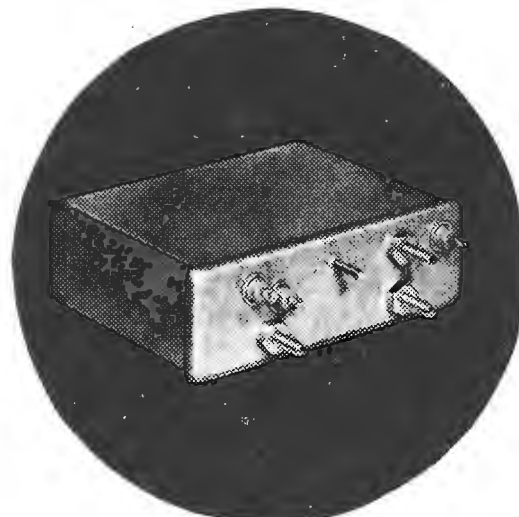

MARCONI

SPECIALIZED COMPONENTS

Please address your enquiries to: **SPECIALIZED COMPONENTS DIVISION**
THE MARCONI COMPANY LIMITED, CHELMSFORD, ESSEX, ENGLAND

2WW-112 FOR FURTHER DETAILS.

BELLING - LEE NOTES

No. 46 of a series.

Is an aerial balun really necessary at u.h.f. ?

A balun is a device for coupling a balanced circuit to an unbalanced one (hence its name), or vice versa. By a "balanced circuit" is meant a circuit which is comprised of two halves of equal impedance, each of which also has a common impedance to earth and to other electrical circuits. A balanced circuit cannot be connected directly to an unbalanced one without becoming unbalanced.

Now a conventional television aerial incorporating a centre fed dipole, and this includes Yagi arrays, is essentially a balanced arrangement. It can, of course, become unbalanced by bad design, or by induction if mounted too close to anything which disturbs the surrounding field asymmetrically; mounting it vertically inevitably disturbs the balance to some extent, however slight. If this occurs, the two halves of the aerial are no longer of equal impedance and the current distribution therefore becomes different in each half, and if a balanced transmission line (the feeder or down-lead) is connected directly to it, the unbalanced component of the aerial current appears in the line, unbalancing it.

considerably more skill and care in its installation if the balance is not to be upset, e.g. by stray capacitances; also, unbalanced receiver inputs are easier and cheaper to produce.

Fortunately, the amount of unbalance of a coaxial cable is small if the diameter of the cable is small compared with the wavelength of the signals to be handled, and this is normal practice in domestic receiving systems. An unbalanced current does flow in the outer conductor (screen), and this in turn means that the current distribution in the two halves of the aerial dipole is unbalanced, which affects the nulls and overall pattern of the aerial's polar diagram; in the case of a transmitting aerial, it also means a waste of power. The effect will be a minimum if the feeder cable is correctly matched to the aerial, i.e. if the characteristic impedance of the cable is of the same value as the centre impedance of the aerial.

The accompanying polar diagrams, recording the performance on channel 33 (567 Mc/s) of a typical 10-element (reflector, dipole, and 8 directors) u.h.f. aerial connected to a coaxial cable with and without a balun, show how slight the effect of a normal coaxial (unbalanced) line is when the aerial and cable are correctly matched for impedance. The small amount of spoliation has *no practical significance under normal domestic reception conditions* where local noise is predominantly thermal, and the

as a balun. The alternative is to alter the centre impedance of the folded dipole, which can be done by varying the cross-section of its limbs along their length, and if this is done correctly, a good impedance match to the cable can be achieved without a transformer. A balun then becomes unnecessary for a domestic aerial.

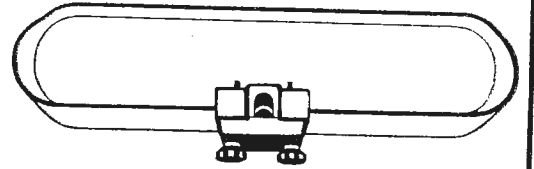

COMPLETE RANGE OF U.H.F. AERIALS

Belling-Lee make a range of u.h.f. aerials from a simple 3-element (reflector, dipole and one director) to an 18-element (16 directors) and a double 10-element broadside array. These aerials provide uniform gain over the four local channels; the graduated dipole is correctly matched to the cable, requiring no balun. They are extremely easy to install. For example, note the removable cable termination, which allows the feeder to be made up on the ground.

VOLTAGE POLAR DIAGRAMS
8 Director array — 567 Mc/s

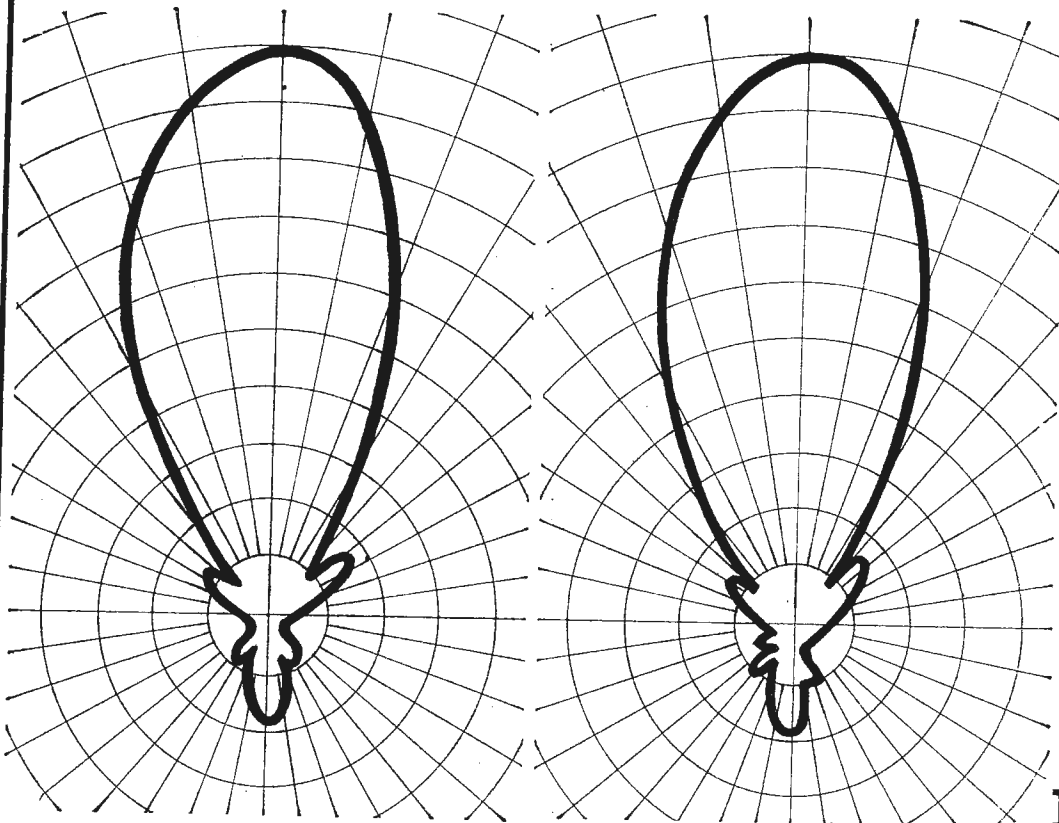

with balun

without balun

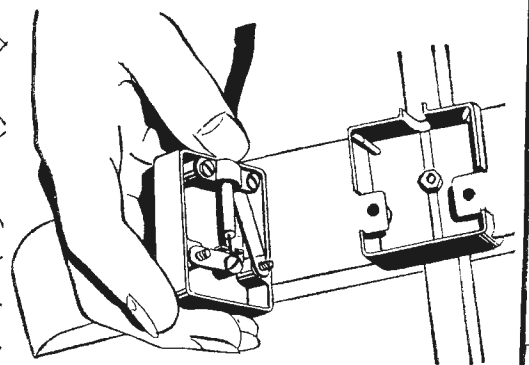

BELLING - LEE

Belling & Lee Ltd.

Great Cambridge Road, Enfield, Middx.

Tel: Enfield 5393

Most Belling-Lee products are covered by patents, registered designs, or applications.

In practice, in order to achieve optimum reception, it is usual to mount television aerials clear of disturbing influences and so, for all practical purposes, balance is maintained. However, in this country, a coaxial feeder is usually employed for conducting the signal energy to the receiver, and this is not a balanced transmission line. The reasons for this practice are that a balanced line needs

back-to-front ratio and directivity are imperceptibly affected as far as the ordinary viewer is concerned. Of course, if there is an appreciable impedance mismatch (say, greater than 2:1) anywhere in the response band of the aerial, the effect will be magnified and it may then be necessary to fit an impedance matching transformer; in this event the transformer can be designed to function also

MANUFACTURERS' PRODUCTS

NEW ELECTRONIC EQUIPMENT AND ACCESSORIES

Travelling Wave Tube Power Unit

A LARGE variety of travelling wave tubes may be operated from a power unit Type 4580 manufactured by James Scott Ltd., Carntyne Industrial Estate, Glasgow, E.2. Supplies are available for helix, collector and second grid which are positive with respect to the cathode and a negative voltage for the control grid as well as a heater supply for the t.w.t. The unit is supplied for use with tubes which have the collector at earth potential, the earth connection being made in the power supply.

The helix supply is variable from 1 to 3 kV positive with respect to cathode at currents up to 2 mA and is stabilized to 0.1% for $\pm 5\%$ variation in mains voltage. Both voltage and current is metered. The collector supply is obtained from a variable 0 to 500 V source which is added to the helix supply giving voltages from 1 to 3.5 kV; currents of up to 30 mA can be drawn.

Grid-2 supply provides 2 mA of current over a continuously variable range of voltage from 100 to 800 V. The grid-1 voltage is obtained from a neon-regulated supply and is variable from 0 to 150 V. A variable heater supply of 4 to 7.5 V a.v. is provided.

Other features of this instrument include a helix-current overload protection circuit, a stabilizer valve protection trip and an interlock system whereby the h.t. supplies can be applied only in the order collector-helix-grid.

The equipment measures $21\frac{1}{2} \times 19 \times 18$ in. The cost is £735.

2WW 322 for further details.

Multi-range Test Set

THE COMBINATION, with a high degree of portability, of a multi-range voltage and current measuring instrument and a chart recorder which also marks the measuring range automatically on the chart should prove valuable in continuous measurement applications. The "Multiscript 3" test set marketed by Smiths Industrial Division, Kelvin House, Wembley Park Drive, Wembley, Middlesex, employs a moving-coil movement with taut-

ligament suspension. The full-scale deflection time of the recorder is approximately 1.5 seconds and direct voltage measurement ($20,000\Omega/V$) is possible up to 500V in eight ranges. D.c. measurements up to 1A can be made in seven ranges. Alternating voltages up to 500V in five ranges are possible and alternating currents can be measured up to 0.2 mA on one range. No ink is required for recording. The equipment weighs 5lb and the dimensions are $245 \times 120 \times 90$ mm.

2WW 323 for further details.

Laser Rods

MACHINED laser rods are available from Stanley Sealey Instruments Ltd., Avery Hill Road, New Eltham,

London, S.E.9. Neodymium-doped glass rods can be supplied with ground and polished flat ends. Other end shapes can also be supplied. Optical systems and reflectors suitable for use with the rods can be produced to customer specification. The company also offer a laser rod machining service.

2WW 324 for further details.

Standard Frequency Receiver

THE FIRST all-British product from Hewlett-Packard Ltd., Dallas Road, Bedford, has recently been announced. It is the 5090A Standard Frequency Receiver, which takes advantage of the recently improved stability of the Droitwich 200 kc/s

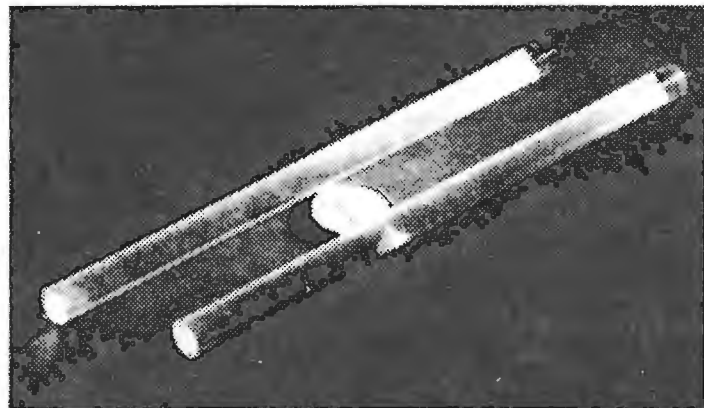

Laser rods machined by Stanley Sealey Instruments Ltd.

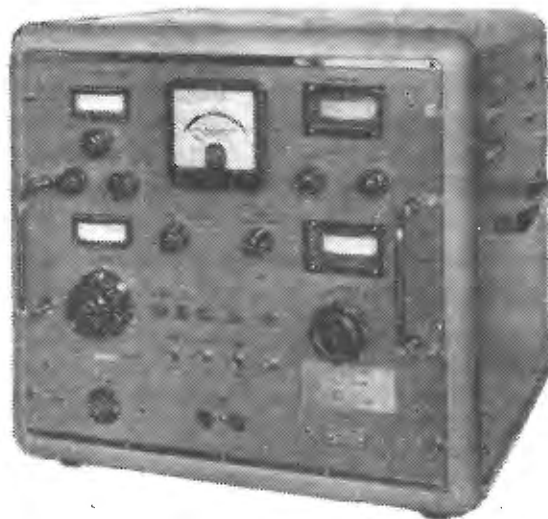

Travelling wave tube power unit manufactured by James Scott Ltd., of Glasgow.

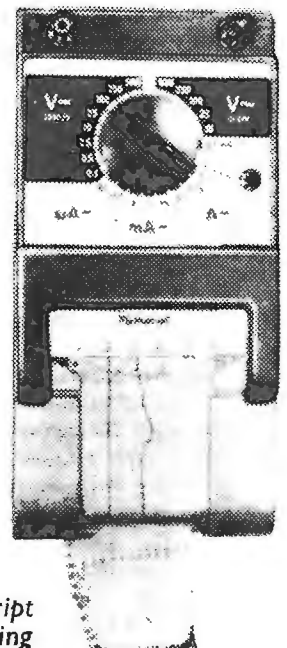

Right: Smith's "Multiscript 3" measuring and recording test set.

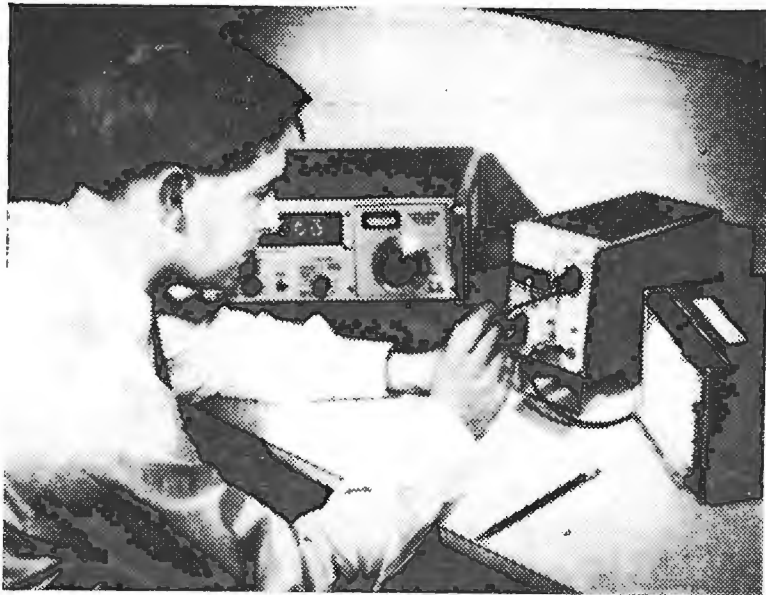

A Hewlett-Packard engineer setting up the 5090A standard frequency receiver during field trials.

transmitter to provide a highly accurate signal for the operation of counters and calibration of instruments. Outputs are provided at 1 Mc/s and 100 kc/s, and a "fail safe" facility is provided whereby no output is available in the absence of a 200 kc/s signal. An internal 100 kc/s oscillator is phase-locked to the standard signal via a frequency doubler, the required narrow bandwidth (0.2 c/s) being obtained by means of an integrating amplifier. An additional phase detector is used to give an output 90deg out of phase with the main one, which is indicated on the meter. Any meter indication then means that the oscillator is locked. This output also drives the signal gate, so that in the absence of lock, no output is obtained. The gate may be bypassed if required.

Facilities are provided for comparison of external frequencies and the standard frequencies, a chart recorder output being provided for this purpose.

Long-term stability is that of the transmitter (5 parts in 10^{10} per day,

reset monthly) although propagation effects at long range may influence this in the short term. Phase delays do not exceed $1\mu\text{sec}$ over the range 0 to 50°C . Sensitivity is $1\mu\text{V}$.

2WW 325 for further details.

30W Amplifier

ELEVEN transistors are used in the Model T636 amplifier manufactured by Trix Electronics Ltd., Maple Place, London, W.1. The equipment can be powered by a 12 V car battery or from an alternating mains supply (115 or 200-240V). Inputs are provided for two microphones and a music source. Separate tone controls are provided for the microphone and music inputs. All three inputs can be faded or mixed and a selector switch enables the music input to be selected from pickup, tape or radio. If the amplifier is used in a vehicle, adjustment for either a positive—or negative—earthed chassis is simple. The power output, with less than 5% total distortion is 30W. Output matching caters for

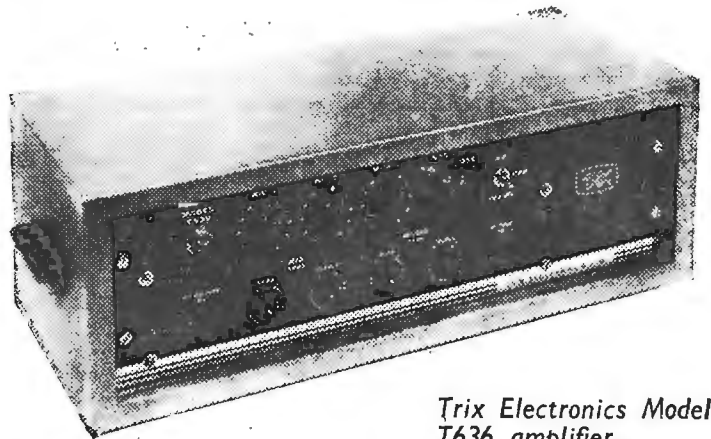

Trix Electronics Model T636 amplifier.

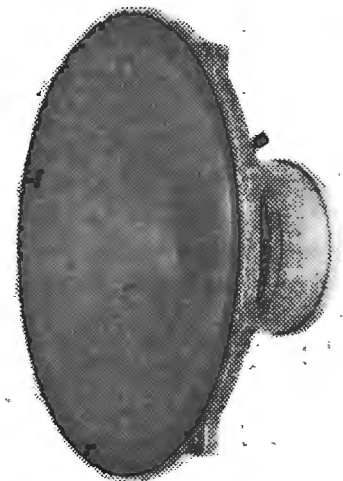

Mk. VII L.F. 15in loudspeaker (Kelly Acoustics Ltd.).

4, 8 and 100Ω lines. The overall dimensions are $20\frac{3}{4} \times 9 \times 7$ in.

2WW 325 for further details.

Loudspeakers

LOUDSPEAKERS recently designed by Kelly Acoustics Ltd., Enfield, Middlesex, are constructed to withstand transient peaks in excess of 100W without damage to the assembly. In these new units the voice coil is embedded in a laminated aluminium former with a polyester resin. The metal former is swaged to both sides of the cone. Of the five units so constructed, four are 12-in speakers (Marks III to VI) the other, the Mk VII L.F., has a 15-in diameter. The Mk III and the Mk IV have power ratings of 15W, the Mk V and Mk VI are rated at 35W. The 15-in unit has a power rating of 50W. A silver grey hammer finish is standard for all models.

2WW 327 for further details.

Time Delay

A ONE-SECOND time delay unit suitable for use over a temperature range of -65 to $+70^\circ\text{C}$ and with d.v. supplies of 18 V to 29 V at 3 A is available from M. L. Aviation Co. Ltd., White Waltham, Berkshire. An

INFORMATION SERVICE FOR PROFESSIONAL READERS

To expedite requests for further information on products appearing in the editorial and advertisement pages of *Wireless World* each month, a sheet of reader service cards is included in this issue. The cards will be found between advertisement pages 40 and 41.

We invite readers to make use of these cards for all inquiries dealing with specific products. Many editorial items and all advertisements are coded with a number, prefixed by 2WW, and it is then necessary only to enter the number(s) on the card.

Readers will appreciate the advantage of being able to fold out the sheet of cards, enabling them to make entries while studying the editorial and advertisement pages.

Postage is free in the U.K., but cards must be stamped if posted overseas. This service will enable professional readers to obtain the additional information they require quickly and easily.

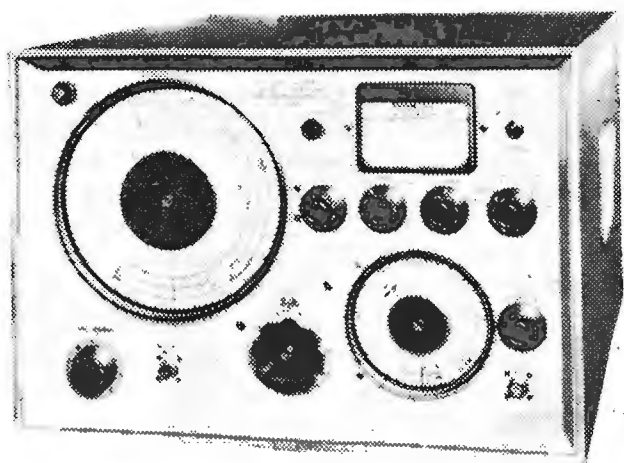

Marconi Instruments signal generator developed for television Bands IV and V test requirements.

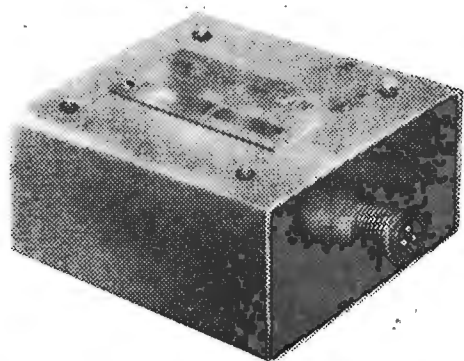

One-second time delay unit manufactured by M.L. Aviation Co. Ltd.

electromechanical relay is operated from a transistor delay circuit. The unit is housed in a hermetically sealed container. Power consumption with the relay energised is 7 W. The unit automatically resets when the power supply is broken. Delays up to 10 seconds can be achieved in alternative types manufactured for a.c. operation.

2WW 328 for further details.

U.H.F. Signal Generator

SIGNAL SOURCE requirements for television Bands IV and V testing are catered for by the Marconi Instruments, St. Albans, Herts, TF1060/3 signal generator. The frequency range extends from 470 to 960 Mc/s and amplitude and frequency modulation facilities are available. A.m. is achieved by an internal 1 kc/s oscillator, the depth of modulation being maintained at 30%. F.m. is applied via variable-capacitance diodes from either internal or external sources and the deviation is variable in three ranges up to 300 kc/s. The maximum power output is greater than 1 mW at all frequencies rising to 25 mW at the higher end of the scale. The minimum output is 110 dB less than the maximum. The source e.m.f. and

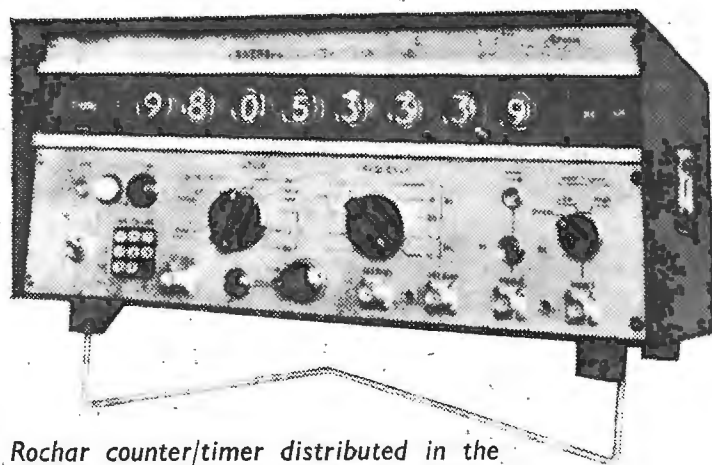

Rochar counter/timer distributed in the U.K. by the Solartron Electronic Group.

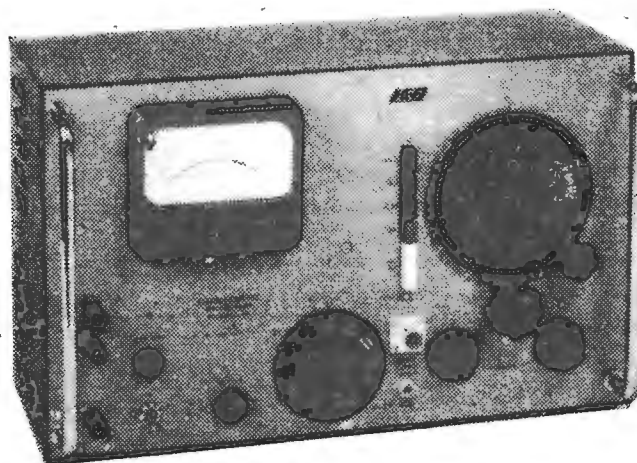

L.E.A. distortion factor meter and millivoltmeter.

power (50 Ω load) are shown on a directly calibrated dial. Carrier level and deviation are indicated on a meter.

Basically, the instrument consists of a coaxial-line oscillator containing a disc-seal triode. Quarter-wave lines between anode and grid, and grid and cathode are tuned by annular plungers coupled to a front-panel control. Variable-capacitance diodes between anode and grid provide f.m. and fine frequency control. Two pick-up loops fitted on piston attenuators provide separate outlets to the monitor and front-panel socket. The equipment is available in bench or rack-mounting versions.

2WW 329 for further details.

Counter Timer

DIRECT frequency measurements from z.f. to 22 Mc/s may be performed with gate times of 0.1, 1 and 10 seconds by the Rochar counter timer Type A1149. Distributed in the U.K. by the Solartron Electronic Group Ltd., Victoria Road, Farnborough, Hants, the instrument can also be used for pulse duration measurement, time interval measurement between two independent pulses, single and multiple period measurement and single and

multiple ratio measurements. Nixie tubes are used in the 8-digit, in-line display panel. The maximum sensitivity is 50mV, but at this level only frequencies between 20c/s and 22 Mc/s can be measured. Over the range z.f. to 22Mc/s, the maximum sensitivity is 500mV.

The oscillator uses an oven-controlled, 5Mc/s crystal. Stabilities of either 1 part in 10^5 or 1 part in 10^9 per day can be ordered. The counter can operate over the temperature range 0—50°C. It can be supplied in 19in, rack-mounting form.

2WW 330 for further details.

Distortion Factor Meter

A **DISTORTION** factor meter, Type E.H.D. 30, manufactured by L.E.A. of rue Jules Parent, Rueil Malmaison (S. & O.), France, is also capable of being used as a millivoltmeter. The fundamental frequency range of the instrument when used for distortion measurements is 25 c/s to 25 kc/s; harmonics up to 100 kc/s are measurable. The input impedance is 1M Ω and voltage levels from 0.1 to 300V are acceptable. Distortion from 0.2 to 100% can be indicated.

The instrument can be used as a

millivoltmeter over a voltage range of 3mV to 300V at a frequency of 25 c/s to 100 kc/s. The equipment can be rack mounted and its dimensions are 43×28×22 cm. The weight is 13.5 kg.

2WW 331 for further details.

Modular Television Equipment

A NEW range of television special effects and test apparatus is being manufactured by Riker Industries Inc. The equipment uses transistors throughout and all the systems are built up from plug-in modules. The range includes mixers, amplifiers, sync-generators and multi-burst generators. The "special effects" generator has some noteworthy features. When required, further modules can be added to this equipment to increase its effects capability. The generator when using seven modules has facilities for wipes, fades and the positioning of circular, square and diamond patterns, etc. in any portion of the picture area. Twenty-nine standard wipes can be produced. In addition, combinations of these are possible. Generators can be obtained for use on both 625- and 405-line systems. The power consumption of the equipment using the 7 modules is 25W. The modules can be mounted in a rack with a frontal area of 3½×19in. Riker equipment is marketed in the U.K. by Livingston Laboratories Ltd., 31, Camden Road, London, N.W.1.

2WW 332 for further details.

Anti-microphonic Cable

MINIATURE, anti - microphonic, p.t.f.e.-insulated coaxial cables are being manufactured by BICC Ltd., Bloomsbury Street, London, W.C.1. During the manufacturing process a layer of graphite is applied to the surface of the extruded p.t.f.e. This conducting layer neutralizes electrical charges that may be produced on the outer braid when the cable is subject to movement. Capacitive interference is minimized by the close contact of the graphite with the insulation. The cables can operate in the temperature range—75° to +240°C.

2WW 333 for further details.

V.H.F. Transmitter

THE "Telecomm" v.h.f. transmitter Type TT20 is a transistor instrument designed for single channel operation in the frequency range 40 to 140 Mc/s. The internal

mercury cell allows approximately 40 hours continuous use. Provided with the transmitter are a lapel microphone and flexible aerial. The equipment is crystal controlled and suitable for use in 25 kc/s channel spaced systems. The peak power output is in the region of ¼W. The transmitter may be combined with the TR20 portable receiver, forming a radio telephone system. Both units are manufactured by The Radio Communications Company, 16 Abbey Street, Crewkerne, Somerset.

2WW 334 for further details.

Bulk Eraser

SPOOLS of magnetic recording tape can be quickly and completely erased by the Weircliffe bulk tape eraser. The spools are inserted into a slot in the equipment. A system of guides and springs ensures that the eraser cannot be switched off before the tape is withdrawn from the eraser. Because of this arrangement, however, the unit must be switched on before the tape can be inserted.



V.h.f. single-channel transmitter (Radio Communications Company).

When the tape reaches the rear of the slot an amber light glows. Withdrawal is spring assisted.

Two models are available, Model 6 accepts up to 8¼-in diameter spools, Model 7 is designed for erasing 6¾×8-in continuous tape cassettes. A 200-240V 50c/s mains supply is required, but instruments can be manufactured to order for other mains voltages. The equipment weighs 33lb and the dimensions are 11½×12¼×7½in. The erasers are manufactured by Amos of Exeter Ltd., Weircliffe Court, Exwick, Exeter. The cost is £29.

2WW 335 for further details.

Milliammeter

THE MEASUREMENT of a.c. in transistor circuits is simplified by the use of the Hatfield Instruments Type LE60 clip-on milliammeter. The probe is clamped on to the conductor. Currents from 0.5 mA to 10 A over the frequency range 20 c/s to 2 Mc/s may be measured. A small slide-switch fitted on the

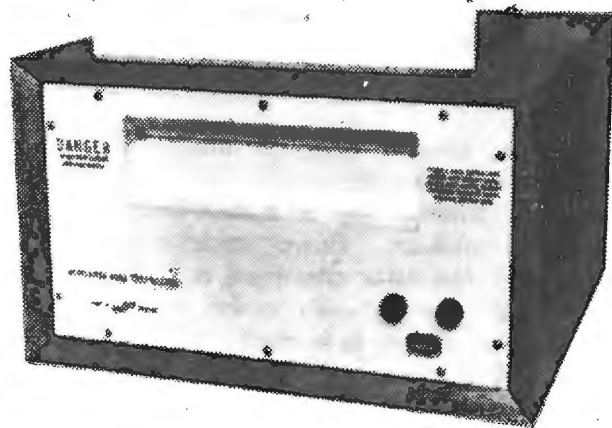

Weircliffe bulk tape eraser.



Hatfield Instruments LE60 a.c. clip-on milliammeter.

probe selects either the low-current ranges or the high-current ranges. These are 0 to 300 mA (in four further ranges, selected on the meter) and 0 to 10 A in three ranges. An output is provided on the meter front panel so that the waveshape can be displayed on a suitable oscilloscope. The impedance reflected into the circuit by the probe is less than $50\text{m}\Omega$ in series with $0.05\mu\text{H}$. The instrument weighs $6\frac{1}{2}\text{lb}$ and its size is $6 \times 5\frac{1}{4} \times 7\frac{1}{2}\text{in}$. When the conductor under test is carrying direct current, the a.c. calibration is unaffected for currents up to 1.5 A.

2WW 336 for further details.

Electromechanical Counting Relay

A SINGLE-DIGIT counting relay, suitable for assembly into multi-digit arrays and having facilities for electronic readout and re-setting is announced by Radiatron, 7 Sheen Park, Richmond, Surrey. The unit must be powered by a 24 V d.v. supply and it will step at a maximum speed of 25 pulses per second. Each one has a digit indication of $7 \times 4\text{mm}$ magnified by a cylinder lens. The relays are plugged into a multi-way socket and are held to a face plate by two screws. When assembled into a multi-digit combination, the relays can be reset individually or simultaneously. Each unit costs approximately £4.

2WW 337 for further details.

Photocell

A HIGH current photocell, Type 9608, is announced by E.M.I. Electronics Ltd., Hayes, Middlesex. It is an opaque-cathode variety with a high-transmission mesh anode mounted close to the flat window and a few millimetres from the plane cathode. Peak currents up to 1A may be drawn. The tube is available with caesium antimony, bismuth silver caesium or silver oxide caesium cathodes.

2WW 338 for further details.

Transistor Power Supply

STABILIZED supplies over the range of 0 to 50V and up to 1A can be obtained from the Type L50 stabilized voltage supply unit manufactured by Farnell Instruments Ltd., Wetherby, Yorkshire. Course and fine output controls facilitate the setting of the voltage required. Output voltage and current can be monitored at two levels of sensitivity by the meter mounted on the front panel of



High current photocell Type 9608 manufactured by E.M.I. Ltd.

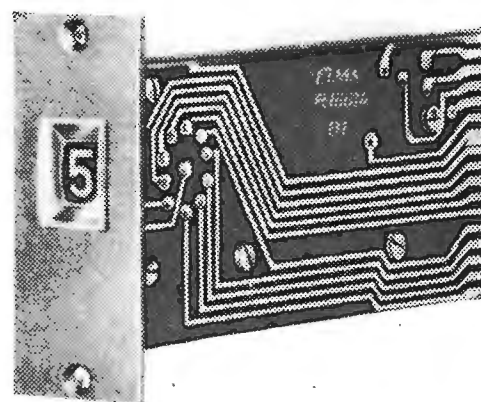

Electromechanical counting relay with direct indication.

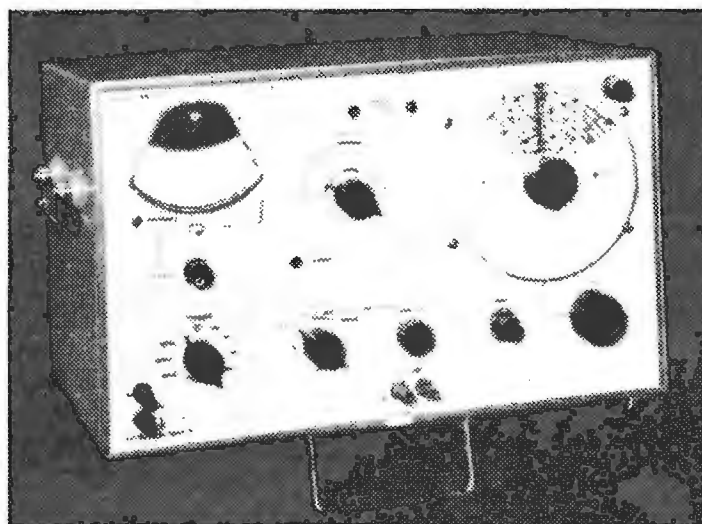

Marconi Instruments wave analyser TF2330.

the equipment. The voltage ranges are 0 to 10V and 0 to 50V, while those of current are 0-100mA and 0-1A. A current limiting device protects the power supply in the event of a short circuit developing externally. On rectification of the fault the output returns automatically to its previous value. On the 0 to 1A current range an overload protection circuit can be set anywhere in the range 150mA to 1A. The price is £75.

2WW 339 for further details.

Wave Analyser

HARMONIC distortion, noise and hum levels down to -75dB are among the measurements that can be made over the frequency range 20c/s to 50kc/s with the Marconi Instruments TF2330 wave analyser. An a.f.c. circuit can be selected to obviate the need for continual re-tuning. Signal amplitudes from $3\mu\text{V}$ to 300V may be applied to the instrument. Two signal outputs are provided, a variable voltage at the frequency of the signal component under investigation which can be used for external monitoring, and a

b.f.o. output the frequency of which being coincident with the voltmeter tuning. The level of this latter signal can be adjusted up to 1V across 600Ω . This output can be fed, via equipment whose frequency response is to be checked, to the input. Amplitude deviations due to the frequency characteristics of the equipment are then indicated on the voltmeter of the wave analyser. An external recorder may be connected in series with the voltmeter.

Semiconductor devices are used throughout the instrument, and the instrument can be energized by a wide range of mains and battery voltages. The weight of the equipment is 24lb.

2WW 340 for further details.

Wideband Voltmeter

R.M.S. voltages, from $100\mu\text{V}$ to 300V can be measured over a frequency range of 15c/s to 50Mc/s with the Keithley Instruments Model 121 wideband true r.m.s. voltmeter. The lowest full-scale range is 1mV. The measuring accuracies of the instrument are within $\pm 1\%$ of full scale from 20c/s to 10Mc/s, $\pm 3\%$ of full

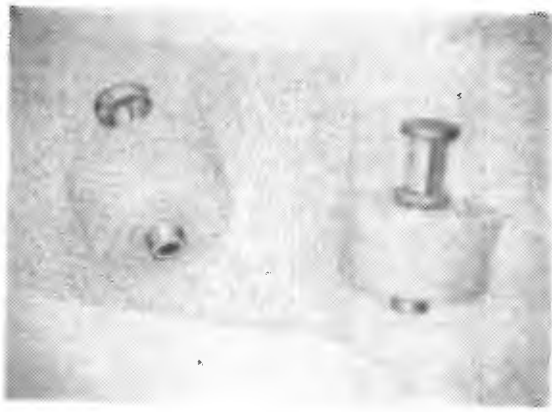

"Press-Fit" Teflon terminals Type FT-SM-71-C10 (Sealectro)

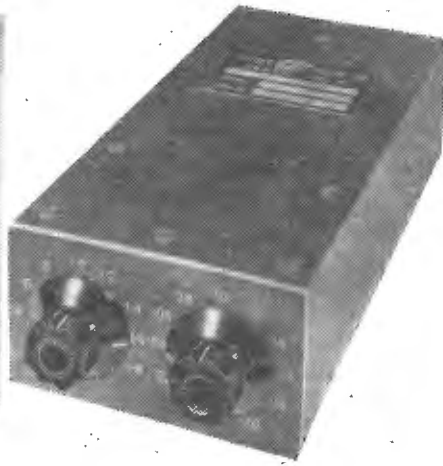

Millisecond time delay unit manufactured by Vacuum Reflex Ltd. It has a delay range of 220 to 2,000 msec in steps of 20 msec, and can be triggered from either pulse or switch.

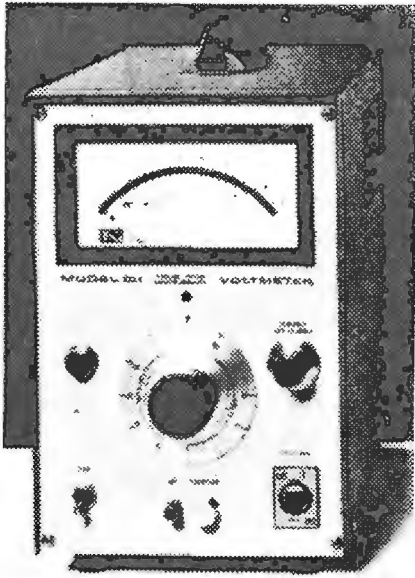

Model 121 voltmeter (Keithley Instruments Inc.).

scale from 18c/s to 20Mc/s and $\pm 5\%$ of full scale from 15c/s to 50Mc/s. The input impedance is $1M\Omega$ shunted by 20pF. This can be increased to $10M\Omega$ (15pF) for signals up to 300mV by using the Model 1201 cathode follower probe. The voltmeter may also be used as an amplifier. When so used, a gain of 100 and a risetime of less than 6 nsec over the frequency range 10c/s to 100Mc/s are achieved.

The price is £356 excluding duty, and the instrument can be obtained from Livingston Laboratories Ltd., Camden Road, London, N.W.1.

2WW 341 for further details.

Feed-through Terminals

A NEW "Press-Fit" Teflon-insulated, feed-through terminal may be used in assemblies where height is limited. Designated the FT-SM-71-C10, the units have a body diameter of 0.264in and an overall height of 0.303in. Thus the large body diameter compensates for restricted height in providing flash-over protection. The maximum

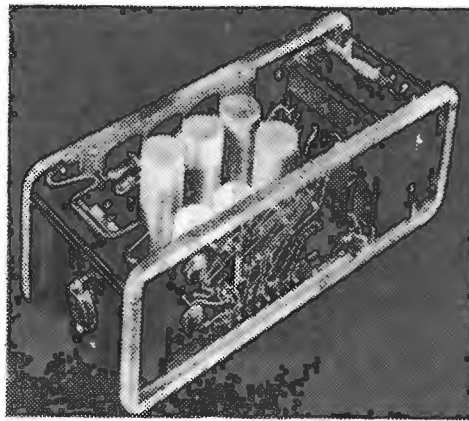

Transistor voltage stabilizer Type PE4862 (Philips).

chassis thickness into which the terminals may be inserted is 0.060in, where it is recommended that a special insertion tool be used. Ten different body colours are available. The components are available from the Sealectro Corporation, Hersham Trading Estate, Walton-on-Thames, Surrey.

2WW 342 for further details.

Process Control Timers and Relays

SOLID state techniques are used throughout a new range of process control timers and relays developed by Vacuum Reflex Ltd., Soho Street, London, W.1. The units in this series are claimed to give stable, accurate delays of long duration and are unaffected by wide ambient temperature changes. Delays of up to 5 minutes are possible. Modules can be connected in series however for longer delays or sequential switching operations. Encapsulated units can be supplied with an initial delay tolerance of $\pm \frac{1}{2}\%$, which is maintained over a temperature range

of -10 to $+55^\circ\text{C}$, and supply voltage variations of $\pm 10\%$.

A typical unit is a time delay relay where the output contacts close after continuous application of a given input voltage for 60 seconds; if the input voltage is removed for more than 100 msec the timing sequence is re-initiated. The output contacts are rated at 240 V 2 A. Other applications of units in the range are switch control with reset facilities, automatic recycling and single shot operations initiated by working contacts and the opening or closing of control contacts. Models having either switched or continuously variable delays are available. Typical of this series is the unit having a maximum delay of 2 seconds, switched in steps of 20 msec.

2WW 343 for further details.

Transistor Stabilizer

A DIRECT voltage stabilizer intended for building into other equipment has been introduced by Philips. Designated the Type PE4862, these units can be obtained in the U.K. through Research and Control Instruments Ltd., King's Cross Road, London, W.C.1. The output voltage can be preset anywhere in the range 1 to 30 V. At 24 V, 1.3 A may be drawn. A differential amplifier ensures that with mains fluctuations of $\pm 10\%$ the output does not change by more than 0.001 of its nominal value. The internal resistance is less than 0.01Ω . The unit can be used in temperatures of up to 45°C . If so required, versions are available as rack-mounting units with mains switch and indicator lamp. A cabinet version is also being manufactured.

2WW 344 for further details.

Servo Motor

A SERVO motor of the permanent magnet type, instead of a conventional wound rotor, embodies a disc-shaped printed circuit. Features of this motor make it particularly advantageous for use as a servo component. It has low inertia and extremely smooth torque down to zero speed. Gearless drives are possible thus eliminating backlash and improving the response rate of the load. The manufacturers are Pye Printed Motors Ltd., Cambridge, and the motors are made under licence from Société d'Electronique et d'Automatisme and Cie Electro-Mécanique of Paris. Four different sizes are available.

2WW 345 for further details.

**THERE'S
A WORLD
OF EXPERIENCE
IN
EVERYTHING
MARCONI'S DO**

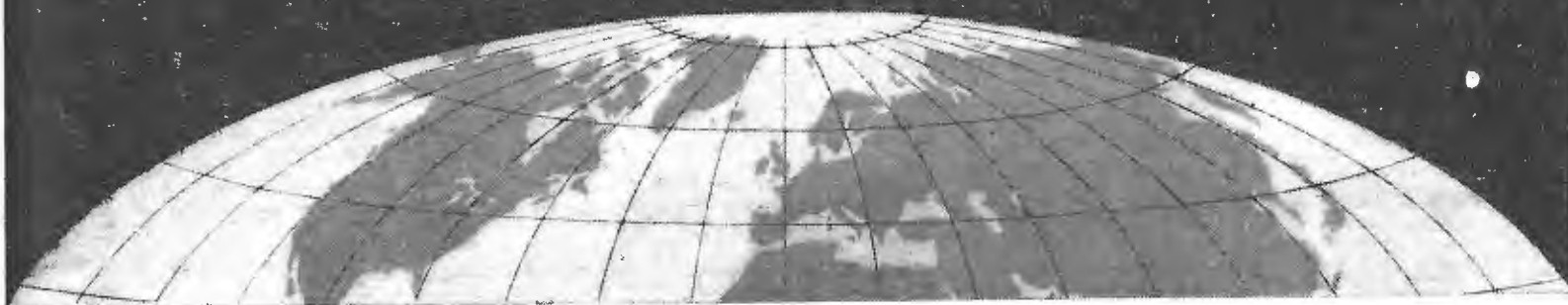

***The Post and Telegraph Authorities of more than 80 countries
rely on Marconi telecommunications equipment***

SURVEYS ★ Marconi's telecommunications survey teams are at work in many parts of the world. Marconi's is the only company maintaining a permanent research group working entirely on wave propagation.

INSTALLATION ★ Marconi's installation teams undertake complete responsibility for system installation, including erection of buildings and civil engineering works as well as the installation of the telecommunications equipment and auxiliary plant.

PLANNING ★ Marconi's vast experience is reflected in the quality of its system planning organisation which is constantly employed on planning major telecommunications systems for many parts of the world.

MAINTENANCE ★ Marconi's provide a complete system maintenance service and undertake the training of operating and maintenance staff, either locally or in England. Marconi's also establish and manage local training schools for Post and Telegraph Authorities.

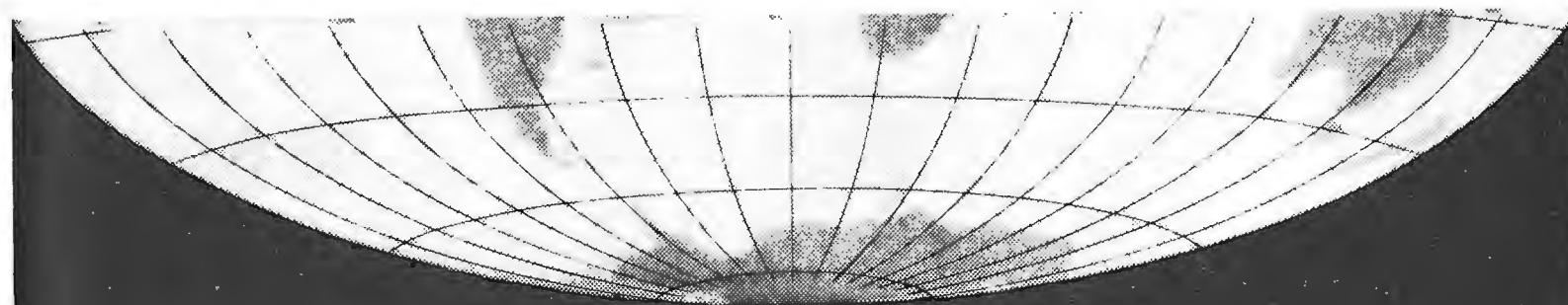

MARCONI

TELECOMMUNICATIONS SYSTEMS

COMMUNICATIONS DIVISION, THE MARCONI COMPANY LIMITED, CHELMSFORD, ESSEX, ENGLAND



is one speech channel enough?

If your H.F. radiotelephone circuits are pushed to the limit or if you find new planning difficult—you need Rediplex for maximum utilisation and lower operating costs. Now for the first time, at low capital cost, Redifon introduce a compact ISB multi-channel system for short and medium distance communication. Four speech channels simultaneously using one carrier. The cost of the transmitting and receiving terminals, including the channelling, is far less than you would pay for regular channelling and displacement equipment—a quickly installed packaged deal. It will pay you to find out more about Rediplex. Write now for full specifications.

The Rediplex system gives you

Four simultaneous speech channels, or any combination of speech, teleprinter, facsimile or tone intelligence signals.

Four crystal controlled spot frequencies, 2 to 16 Mc/s.

100 watts p.e.p output, continuous rating (or 750 watts with the G.A.406 amplifier).

Compatible with Standard International ISB systems.

Completely transistorised receiving terminal and transmitter drive unit.

Modular construction and printed circuits.

Alternative power supply units for a.c. mains or 24 volts battery supplies.

Redifon

REDIFON LIMITED Communications Sales Division
Broomhill Rd., London, S.W.18. Tel: VANdyke 7281
A Manufacturing Company in the Rediffusion Group.

2WW-115 FOR FURTHER DETAILS.

☐ R×2

FIRATO 63 IN AMSTERDAM



THE 13th International exhibition organized by the F.I.A.R. association of Dutch manufacturers, importers and agents in the field of radio and electronics was held for the second time in the large new RAI exhibition buildings in the Europaplein in Amsterdam. It was evident after the first essay into these new premises in 1961, that the character of the exhibition, which had been established by the late Mr. Kazemier in the post-war years, had entered on a period of transition and that the foundations of the organization would have to be extended to carrying the expected future expansion. Accordingly an agreement was made with the owners of the building (the R.A.I. motor industry organization) for substantial backing; and the Netherlands Television Service also participated on a much increased scale.

Firato is the oldest established international radio exhibition in Europe and has been consistently supported by American, Belgian, Danish, French, German, Italian, Hong Kong, Japanese, Swedish and Swiss manufacturers. This year the British participation was considerably strengthened by the Audio Manufacturers Group of B.R.E.M.A. who staged a combined exhibit and laid on a representative demonstration of high-quality sound reproduction which, in spite of the small size of the listening room, reached a standard which obviously impressed our Dutch friends favourably—and even satisfied your reporter. The advance hearing of the master tape of Decca's new stereo recording of "Carmen" was particularly impressive.

Next to the British Audio Group was an educational exhibit. "The Electron" contributed to by the Dutch Post Office, Armed Services, Broadcasting Union (N.R.U.), Philips, N.V. Electrologica and the Technical High School at Enschede.

This was arranged to take visitors in sequence from working models and diagrams of electronic structure in matter, valves, semiconductors and typical circuits to the more advanced communications and radar applications. A description of this exhibit would require a separate article, but we were particularly interested in the replica of a listening post at Scheveningen Radio PCH—a station which was working (on spark) in 1904 and is now one of the busiest coastal radio stations in the world with transmitters and receivers spread over the whole of Holland (4 medium-wave for telegraphy and 8 medium-wave and 5 short-wave transmitters for telephony). The central control office is at IJmuiden. The PTT exhibit also included demonstrations of the Mobilfoon telephone service to cars and of the unique Simafoon service of narrow-

band code signalling (described in this journal in January 1963) and now renamed Semafoon to avoid confusion with the products of another telephone manufacturer of world renown. The television wire relay experiment in The Hague, using normal quad telephone wiring for distribution, is still running successfully, and plans are afoot to extend the "experiment" to give a choice of three television and 12 v.h.f. sound programmes in about 6,000 homes. Modulation of foreign TV programmes will be converted where necessary so that viewers will not have to buy "universal" sets.

This year the professional electronics sector was segregated in the North Hall of the exhibition. Admission was by invitation (and free) and there was a separate entrance so that visitors need not pay the normal exhibition admission charge. Nevertheless, most customers, having concluded their business in the electronics section, paid to see "how the other half lives." The electronics sector was not so heavily dominated by the American big battalions as in some earlier Firato's though they were, of course, in evidence. Many leading British component manufac-

The group exhibit of nineteen British audio equipment manufacturers, was a prominent feature of this year's Firato.



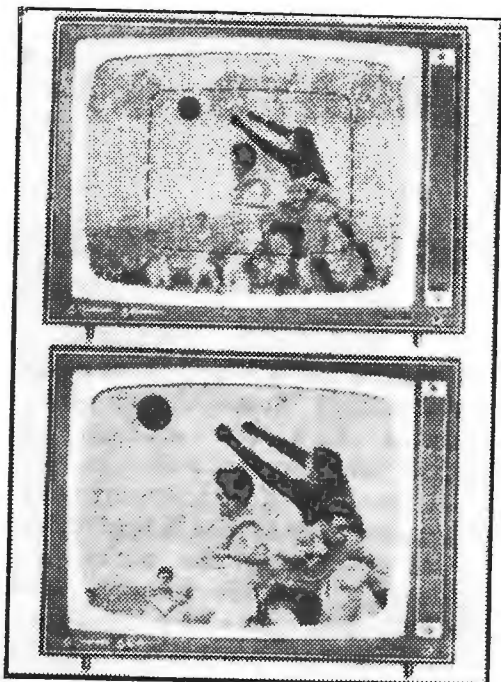

Push-button picture enlargement is a feature of the Erres TV5639 receiver.

turers e.g. Painton, McMurdo, Widney-Dorlec were well represented and appeared to be doing good business. Kerry's gave demonstrations of ultrasonic drilling and Imhof's, as usual, had driven their touring showroom into the hall and were using it as their stand. On the large Philips stand in this hall, many new instruments and components were being shown, notable examples being the GM2308 wobulator and GM5600 and 5601 oscilloscopes for television servicing and the PM5320 f.m./a.m. generator—all good-quality medium-priced instruments. New transistor TV monitor units included EL8100 (6½in) and EL8105 (8in), and there was a new series (PM1000) of high-quality industrial cameras with 8Mc/s ± 0.5 dB response and gamma correction. A camera head with 50mm, f0.75 lens is available. The PM1051 with Schneider motor-controlled iris and automatic tube voltage control can be adjusted to give constant output, either on peak white or average illumination over a range of light intensity of 1:300,000.

Philips were showing many new components including a range of 10-pin valves for television sets, a travelling wave tube (YH1030) for the 5.9-7.2 Gc/s band, new 21 cm and 36 cm 90° monitoring tubes, a ½ watt, 180 Mc/s transmitting transistor (AFY19) and a range of thyristors (s.c.rs.).

Domestic television receivers in Holland look much the same as those in other European countries, but they include multi-standard types which make our dual-standard sets seem relatively simple. The sets are designed to receive not only the

Dutch but, in the South of Holland, the French, Belgian and German transmissions. In the Philips 23TX380A receiver the line frequency and modulation polarity, formerly selected by separate switches are now automatically coupled with the channel selector switch. This is a feature also of the latest Erres (TV9645) set, which now makes no secret of the fact that its chassis is made by van der Heem and that the commercial backing comes from Stokvis. These sets, like most other models, make provision for u.h.f. reception as well as v.h.f. One Erres set, the TV5939, incorporates the novelty of push-button picture enlargement, whereby a central area of the normal scan is pulled up to full screen size (and down to the much-maligned 405-line standard, of course).

The Japanese flair for miniaturization, seen already in pocket-transistor sound receivers, is now being applied to television. Two makes—the Sony 5-303E "Micro TV," and the Hayakawa TRP-601 "Sharp"—gave 6-inch gems of pictures with no apparent line structure. At the other end of the scale was to be seen the "Beamscope" (also of Japanese origin), which is a Fresnel-type lens in thin plastic material giving up to 50% magnification when placed in front of a normal set. It has concentric prismatic grooves at ¼ mm spacing impressed in the front surface. These are normally not visible, but they refract light as a thick spherical lens might do. The price in Holland was equivalent to £12 10s.

The Bell Telephone Manufacturing Company (I.T.T.) were showing a very wide range of domestic television and radio receivers. These are being made in Antwerp for the

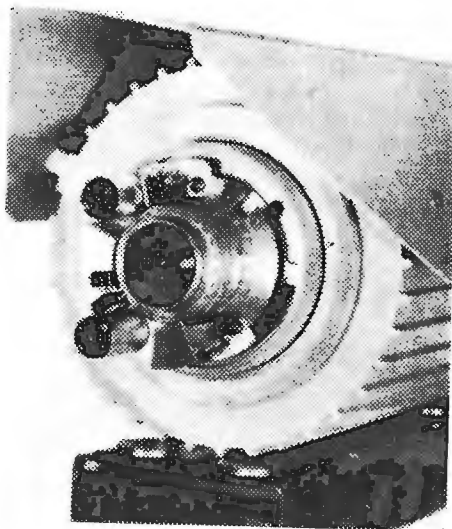

Schneider lens and motor-controlled iris in the Philips PM1051 heavy-duty automatic industrial TV camera.

European market, and were shown by Holland-Impex N.V.

Most of the Dutch manufacturers as well as the leading German firms who were in the exhibition were demonstrating stereo radio receivers. These were working on signals in the hall radiated from a low-powered transmitter which was specially licensed for the duration of the exhibition. Other radio receivers which attracted attention were the amateur radio equipment made by the Italian firm of Geloso and the Eddystone communications receiver with panoramic unit which was seen working on the stand of J. J. de Kort of Hilversum.

In the East Hall of the RAI building the NTS (Netherlands Televisie Stichting) were operating the largest studio so far put into service in

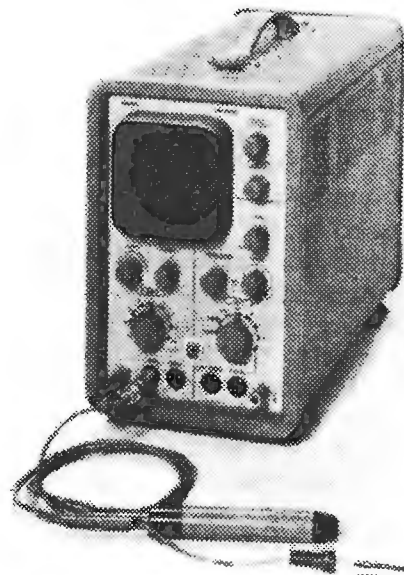

Philips Type GM5600 service oscilloscope.

Holland and were making the most of the experience as a prelude to the move from the present small studios in Bussum into the new Television Centre now under construction near Hilversum. To Amsterdam they had transported scenery, O.B. vans and all the paraphernalia of dressing rooms, canteens, etc., which go to the making of live TV programmes and were putting on five shows per day, each to an audience of 1,000. Those who were unable to get seats could watch the show from a promenade overlooking the stage, well provided with monitoring screens for those not fortunate enough to get near to the glass.

Thus the Firato provides something for everybody and all may follow their interest with comfort and convenience. Whatever may be the future of national and international exhibitions we have a feeling that this show, as at present organized, will always have a place in the calendar.

Genoa Fair 1963

TELECOMMUNICATIONS FOR SHIPS AND AIRCRAFT

AN effort is being made at Genoa to provide an annual exhibition of equipment used in marine communication, air communication and telecommunications. On the telecommunications side the organizers expect the fair to provide manufacturers with a place to show their equipment to a wide range of operators of ships and aircraft as well as to engineers of telecommunications organizations.

Genoa is in the booming Turin-Milan-Genoa triangle and this, together with the aircraft exhibition, the international meeting on communications and the international meeting of port authorities which were held at the Fair from the 5th to 20th October ensured a substantial number of the right kind of visitors.

Viewing conditions are very different from those one finds at British and most other exhibitions. The fair is held on land reclaimed from the sea in the best part of Genoa harbour. The telecommunications building is the tallest in the fair and the first five of its ten floors were used for this, the first exhibition. Dividing the exhibition up into five sections in this way seemed to produce far less tiring conditions than at the long, wide, one floor exhibition one is accustomed to. Strips of floor-to-ceiling glass windows placed every few yards provided views of the Mediterranean. A tour of the telecommunications exhibits could be interrupted half way and a trip taken across the harbour in a launch provided by the Fair authorities to see the aircraft on show at the Cristoforo Colombo airport. All this in sunny weather superior to the best we have had this summer in the U.K.

Of the Italian companies exhibiting, Telettra of Milan, who have been having increasing export success in recent years, were showing new microwave link equipment and test instruments. Their H22 FM link system is designed to operate in the 10,700 to 13,250 Mc/s band. With one klystron the tuning range is 500 Mc/s. Peak deviation is 6 Mc/s and the equipment can handle one 525 or 625 monochrome or colour TV channel, or one closed circuit TV channel with one facsimile channel, or 120 p.c.m. channels. Also shown was their DT24 system, a time division pulse-code-modulation multiplex equipment suitable for the establishment of medium-capacity telephone links in place of conventional v.f. systems. Intended to be used with their H22 radio system, it is practically unaffected by noise produced on the physical circuit. A useful range of measuring instruments for the audio, carrier and low radio frequencies was on show. This part of the frequency range is not particularly well covered by the commercial instrument manufacturers and some of Telettra's instruments seem to fill gaps in the range of commercially available instruments. Selective voltmeters covering the frequency range 20 kc/s to 6 Mc/s and 50 c/s to 15,000 c/s are

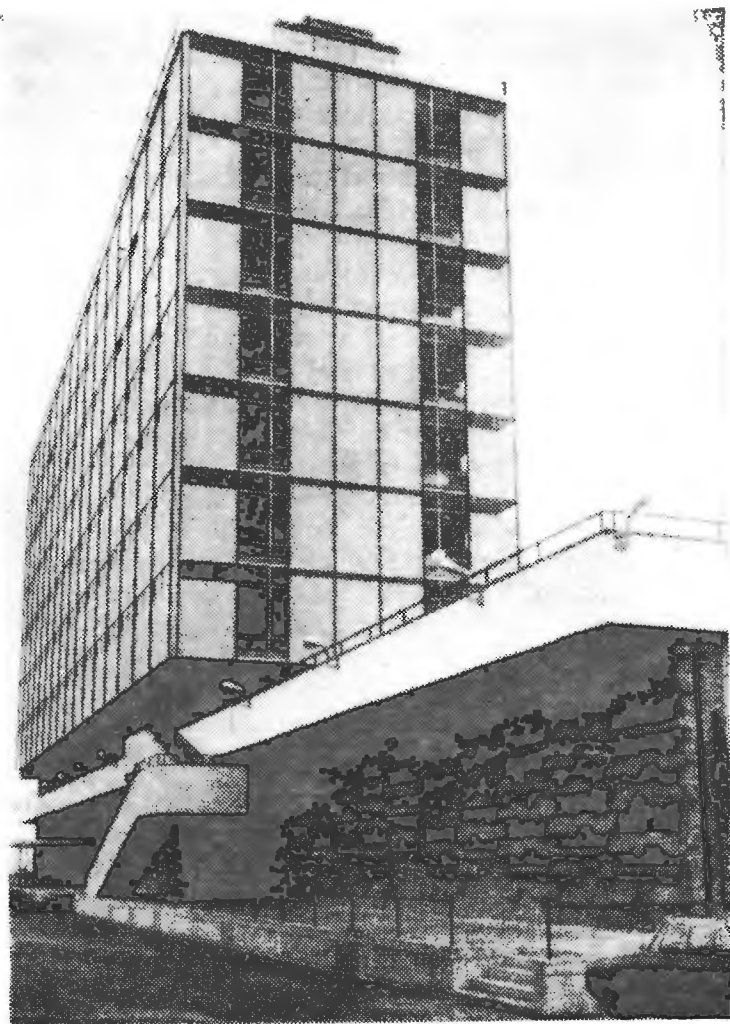

available. The first of these voltmeters has a sensitivity of from $10 \mu\text{V}$ to 3 V with a minimum reading of $2 \mu\text{V}$, and the other one has a sensitivity of from $10 \mu\text{V}$ to 100 V with a minimum reading of $1 \mu\text{V}$.

A swept frequency selective amplifier voltmeter covering the frequency range 200 c/s to 1300 kc/s has recently been introduced. Used with either a sweep oscillator or a manually tuned generator it provides a measurement range of +22 dBm to -98 dBm, with a minimum reading of -115 dBm. The 3 dB bandwidth is ± 100 c/s. As a logarithmic voltmeter the range is 60 dB. A prototype of the Janus system of collision avoiding radio equipment was on show. This is a shipboard equipment designed for bridge-to-bridge working. Information on the ship's course, whether or not at anchor, and if at anchor the ship's position is transmitted regularly and automatically. Manual signalling and voice communication facilities are also fitted.

Medium and high frequency marine radio telephones were shown by Societa Italiana Radio Maritima. One transmitter/receiver, the Mizar 63, which measured $39 \times 17.5 \times 36$ cm had a power output of 70 watts. The transmitter is designed to operate on spot frequencies in the 1600 to 2850 kc/s, and 8 to 9 Mc/s bands and the receiver provides continuous coverage from 500 kc/s to 3 Mc/s and 8 Mc/s to 9 Mc/s.

Selenia of Rome showed their Meteor 200 model RMT-1C weather radar. A large order for this equipment has recently been received from Sweden. It is an X-band, 200 kW peak power radar with a p.r.f. of 1200 or 240 at pulse widths of $0.5 \mu\text{s}$ and $0.3 \mu\text{s}$. Maximum range is 250 miles and p.p.i. and r.h.i. presentations are available. Iso-echo facilities can be switched on on both types of display. The company, a member

of the Raytheon group, were also showing marine radars and microwave relay systems designed and built in Italy.

Litton Industries, the American company were showing inertial navigation equipment and electronic test equipment in the aircraft exhibition. This equipment has been shown before but they did announce that the depth of their range of 10 to 1 potentiometers has been reduced to half an inch.

A number of British, European and American companies had stands. Solartron and EMR, both members of the same group each had a stand, and a wide selection of equipment was shown by Philips of Eindhoven. A particularly impressive display of measuring instruments was seen at the Marconi Instruments stand. All the instruments on show had been seen at other exhibitions this year, but advance information on new additions to their range of modular electronic instruments was available in their new catalogue which had just been printed.

The Marconi Instruments stand formed part of the luxurious Marconi Italiana stand. The Marconi Company of Chelmsford also had space on this stand. A

great deal of interest was shown in the Marconi Italiana all-transistor multichannel radio link equipment, Type MH141. Designed to work in the 5925 to 8500 Mc/s band, the frequency deviation is 200 kc/s per channel and the capacity is 300 to 400 channels.

While discussing colour television systems with engineers from Radiotelevisione Italiana at their stand it very rapidly became clear that their choice for the European standard was PAL. This preference was stated most emphatically. Very different from the way B.B.C. engineers expressed themselves in July during the demonstration to the E.B.U. *ad hoc* colour group.

While there were very few visitors on the first day of the fair the grounds were crowded on the 2nd day, and after a fall in numbers on the third and fourth days the number of visitors, particularly the technically qualified, began to rise very substantially. A slow start was perhaps to be expected at an exhibition lasting so long—fourteen days—but to judge by the way the numbers had increased by the fifth day the total over the period will be very substantial.

R.B.

BOOKS RECEIVED

Essays in Electronics, by "Cathode Ray". A collection of twenty-two articles previously published in *Wireless World*. This book is complementary to "Second Thoughts on Radio Theory" and is the author's own selection from his writings during the past eight years. Pp. 301. Iliffe Books Ltd., Dorset House, Stamford Street, London, S.E.1. Price 42s.

British Standard 1991: Part 6: 1963. Recommendations for letter symbols, signs and abbreviations in electrical science and engineering, including electronics and telecommunications. Pp. 51. British Standards Institution, 2 Park Street, London, W.1. Price 12s 6d.

Batteries. Edited by D. H. Collins. Proceedings of the 3rd International Symposium held at Bourne-mouth, October 1962. The full papers and discussions recording developments in primary and secondary cells, solar batteries and fuel cells. Pp. 464. Pergamon Press Ltd., Headington Hill Hall, Oxford. Price £6.

Der Transistor, by H. Salow, H. Beneking, H. Krömer and W. v. Münch. Volume 15 in the series *Technische Physik in Einzeldarstellungen*. Reviews (in German) the physical basis of transistor action, the technology of production, general circuit theory and a final chapter on special types, including tunnel diodes, phototransistors, unipolar and double base diodes. Pp. 426. Springer-Verlag, Berlin/Göttingen/Heidelberg. Price DM82.

Ultrasonic Delay Lines, by C. F. Brockelsby, B.Sc., A.R.C.S., A.M.I.E.E., J. S. Palfreeman and R. W. Gibson, B.Sc. (Eng.), Grad.I.Mech.E. Surveys the development and gives the basic design principles of liquid, solid (including wire) and other forms of electroacoustic time delay devices used in radar, colour television and correlation techniques. Pp. 297. Iliffe Books Ltd., Dorset House, Stamford Street, London, S.E.1. Price 65s.

Les Fonctions de la Variable Complexe, by A. Kaufmann and R. Douriaux. Advanced mathematical textbook (in French) on the theory and applications of complex quantities and functions in engineering, including electrical networks. Pp. 427. Editions Eyrolles, 61 Boulevard Saint-Germain, Paris V^e. Price NF81.60, by post.

B.B.C. Engineering Division Monographs.

No. 47. "Vertical Aperture Correction Using Continuously Variable Delay Lines", by D. Howorth, B.Sc. Tech., Grad. I.E.E.

No. 48. "The Development of B.B.C. Internal Communications", by J. M. Chorley, A.M.I.E.E., and J. S. Norwell.

No. 49. "Apparatus for Measurement of Non-linear Distortion as a Continuous Function of Frequency", by H. D. Harwood, B.Sc., A.Inst.P., A.M.I.E.E., includes some interesting results from the application of this method to loudspeaker testing.

The prices of the above, which are obtainable from B.B.C. Publications, 35 Marylebone High Street, London W.1, are 5s each by post.

Printed Wiring and Printed Circuit Techniques.

Survey of the materials, processes and recommended standards involved in production. Pp. 49. Prepared by the Electronic Engineering Association and printed by Iliffe Books Ltd., Dorset House, Stamford Street, London, S.E.1. Price 5s (5s 5d by post).

INFORMATION SERVICE FOR PROFESSIONAL READERS

To expedite requests for further information on products appearing in the editorial and advertisement pages of *Wireless World* each month, a sheet of reader service cards is included in this issue. The cards will be found between advertisement pages 40 and 41.

We invite readers to make use of these cards for all inquiries dealing with specific products. Many editorial items and all advertisements are coded with a number, prefixed by 2WW, and it is then necessary only to enter the number(s) on the card.

Readers will appreciate the advantage of being able to fold out the sheet of cards, enabling them to make entries while studying the editorial and advertisement pages.

Postage is free in the U.K., but cards must be stamped if posted overseas. This service will enable professional readers to obtain the additional information they require quickly and easily.

First International Telemetry Conference

LONDON, 23RD TO 27TH SEPTEMBER 1963

SINCE 1950 when the first joint meeting was held in Philadelphia, proponents of both the military (largely "aerospace") and the industrial sections of the art have met in the U.S. in the National Telemetry Conferences. This year a major step forward was taken with the inauguration of the International Telemetry Conference in London. This was sponsored in America by the Institute of Aeronautics and Astronautics, the Instrument Society and the I.E.E.E., and, in the U.K., by the Brit. I.R.E. and the I.E.E. The I.E.E. were the "host" organization, the Conference being held in the Institution building at Savoy Place.

Scope of the Conference:—Because of the many technologies involved telemetry is a wide and complex subject. Also, because of the way in which these technologies interlock, it is not easy to arrive at clear-cut divisions for discussion. This occasion was no exception, and it was evident that the joint programme committees had encountered this problem which had been made more difficult by the need to compress a total of 59 papers into what was effectively a period of only three and a half days.

Nevertheless the original conception of two main types of telemetry was brought out from time to time, particularly in connection with what was perhaps the most controversial issue raised during the Conference—Has telemetry reached maturity?

As with all good debating points, a considerable number of arguments were put forward on both sides, one outcome of which was to enable a picture to be obtained of the relative state of development reached in specific areas. Thus it became clear that, defining maturity as a state of complete development, this was much more likely to be achieved with public utility telemetry (i.e. pipe line control and electricity distribution systems) than with systems for aerospace vehicles. Public utility requirements and hence telemetry design can be frozen at an early stage, whereas aerospace vehicles and their instrumentation systems are almost invariably under continuous development. For public utility and similar applications telemetry systems have been produced which could be described as mature at the time they came into use.

The last point was brought out clearly in "Thirty Years of Grid Telemetry" by Mr. P. F. Gunning. Equipment described in this paper gave the performance demanded of it and did not have to be replaced by new systems until fresh operational requirements arose. For instance the "phototelemeter," introduced in 1935, remained in service for nearly 20 years. This and other grid telemetry systems associated with the 30 years period covered by Mr. Gunning were shown working in their original form in the conference exhibition at Savoy Place.

Technical Thought and Practice:—The speakers whose names have already been given were those

who set the scene in the opening session of the Conference. From there on presentation was in the hands of rapporteurs with the object of giving the maximum possible time to discussion.

Most of the American papers were concerned with aerospace matters, notable exceptions being papers on oceanographic and biomedical telemetry, and a description of a supervisory control system for a large natural gas pipeline network stretching from the Mexican border to the eastern seaboard of the northern States.

Working Speeds

The last system was of particular interest in that it was the first of its kind in the United States and had only been brought into use comparatively recently (installation was in 1962). Although not operating in the 150,000 bit/sec range of the Goddard Data Central scheme, this pipeline telemetry system was entitled "high speed" by virtue of its working speed of 1,000 bauds (bits per sec). Several speakers remarked on this value and contrasted it with the much lower speeds adopted in the past for many public utility applications, especially for the main electricity supply links in the United Kingdom. Obviously speed of operation is limited by the bandwidth which is available. This clearly has an economic aspect—cost increasing with the bandwidth which is made available. However it was stated in the paper that in 1960 the Bell System Dataphone provided a data handling facility with a system rate 80 times that of an ordinary telegraph circuit at only four times the cost, and that overall the "per-bit rate" became cheaper with increase in bandwidth.

In the circumstances therefore the fact that a contract was awarded to a British company in 1960 to supply a 1,200 baud system for a pipeline in Asia became significant. The main features of the system were outlined by a representative of the firm concerned (Serck Controls Ltd.) during the discussion period.

This account was followed by one from Ferranti (Edinburgh) of an X band microwave radio link using pulsed magnetrons operating directly from digitally coded telemetry signals. The link had been supplied for another Serck Controls installation—for the Das Island offshore oil project—and all the equipment from both firms had had to be designed to withstand the extremely adverse environmental conditions of the Arabian Gulf. A set of demonstration equipment was shown in operation at the concurrent International Telemetry Exhibition at the Hilton Hotel. This set incorporated a representative selection of Serck Controls telemetry equipment working in conjunction with Ferranti radio link units of the Das Island type.

At this point it is apposite to consider the position

reached with "public utility" telemetry in Europe, and in the United Kingdom in particular, and—in the light of comment at the Conference—to compare it with that in north America. More than one speaker from the U.S. did not hesitate to say that "power industry" telemetry systems in the U.K. and Europe were ahead of their American counterparts. This situation was also evinced by the Hilton Hotel exhibition where all the British and European firms in general were concentrating to a great extent on industrial telemetry in one form or another, whereas the American exhibitors were concerned more with aerospace techniques and equipment.

There will, of course, always be a number of fundamental differences between the two fields. Nevertheless, there is an increasing tendency for many basic techniques to become common to both.

P.C.M. and T.D.M.

One of the most outstanding examples of this trend is the adoption of pulse code modulation and time division multiplexing for telemetry systems for American aerospace vehicles such as the Minuteman missile, and, in parallel, for the more sophisticated industrial telemetering and telecontrol systems. The main differences lie in the degree of complexity of the individual pulse group "words" together with the redundant pulses (e.g., parity bits) included in them for error checking, recognition, etc., and in the methods used for scanning synchronization.

Thus the p.c.m. code used for the Minuteman missile is based on a 27-bit word. The last three bits of the 27 are used to give word identification; as for instance in the "telemeter word" where two 8-bit analogue data blocks converted into digital form are separated by an 8-bit digital block containing guidance and control data. For the Compagnie des Compteurs system for electric power networks a 25-bit word is used, but in this case 9 bits are utilized for checking—5 bits (numbers 9 to 13) for the complementary value of the address, itself sent as a 5-bit group, and 4 bits (numbers 22 to 25) for transmitting in natural binary code the number of "ones" in the word. It is of interest that the code structure adopted for the U.S. high-speed pipeline system is considerably more complex than this, two 36-bit words being contained within an 82-bit message block. The actual information is carried by the first 36-bit word and the second consists of the same number of bits to give a complement check of the information word. The remaining 10 bits are spaced on each side of the two main groups to provide 5-bit start and 5-bit stop signals. It will be appreciated that such a large amount of redundancy should provide the high degree of system integrity which is considered necessary for this type of application. It was stated that "no information was preferred to bad information," i.e., the latter is rejected whenever errors are detected, a measure which is usually provided for in most public utility supervisory schemes.

The other main element of time division multiplexing, namely, synchronization, is achieved either as a direct locking action or by some form of "start-stop" or periodic correction applied at the receiving end. A method which appears to fall in the first category is employed in the Westinghouse binary-coded decimal ("Westronic") system in which a master generator at the central control station drives transistor scanning systems at both master and out-

stations. This equipment was shown at the I.T. Exhibition, where it was intimated that this was a three-frequency system in that the synchronizing drive signals were transmitted on a "middle frequency." The other two frequencies are used to transmit information by conventional two-tone methods, signals being held in a temporary store or register at the receiving end from which they are transferred to the final (control) register through standard gating circuits, provided synchronism over the scan period has been "proved" and parity checking has been carried out satisfactorily. System operating speed lies between 100 and 250 bauds, the upper limit being extended to 350 bauds when required subject to the additional communication bandwidth being available.

The G.E.C. (Electronics) "Teledata" equipment is typical of frequency division multiplexed systems designed to work over G.P.O. or equivalent circuits. The gear is fully transistorized and its working range of -10°C to $+45^{\circ}\text{C}$ may be taken as being representative, somewhat higher figures being given for the transmitter section and for storage and transportation. In its standard form the system provides 24 basic channels, demultiplexing being carried out by conventional bandpass filters.

One system of interest, described at the Conference, had been developed by S. Smith and Son specifically for use in coal mines, and to meet the requirement for intrinsic safety. The intelligence which has to be passed from the working areas to a central control station on the surface may either be in analogue or on/off form, and time division working using a solid state multiplexing switch was adopted. Solid state devices are, in fact, employed throughout, their low working power level making a significant contribution to satisfying the intrinsic safety criterion.

In the equipment shown a relatively small number of data channels—six—were provided; transmitting units and receiver being linked through a phantom transformer arrangement in order to economize in the number of conductors required. Power supply to the remote units, and their signals in the reverse direction, are carried over this common cable network. The phantom transformer system is stated to give the necessary d.c. isolation between the receiving equipment and the underground units. Construction of the underground transmitter units is based on plug-in printed circuit boards contained within $\frac{1}{4}$ in thick steel cases. External connections are made through waterproof plugs and sockets specially developed for this project, and having extremely low contact resistance and extraction force.

Mechanical Engineering

An outstanding paper falling in the "Industrial System" category was concerned with the telemetering system evolved by the Central Electricity Research Laboratories for the study of the vibration behaviour of steam turbine blades under working conditions.

Several unique problems were encountered during the development of the steam turbine telemetering equipment, particularly with regard to the high temperatures (150°C) and accelerations (5,000 g) and the presence of steam and water. The "capsule"

(Continued on page 567)

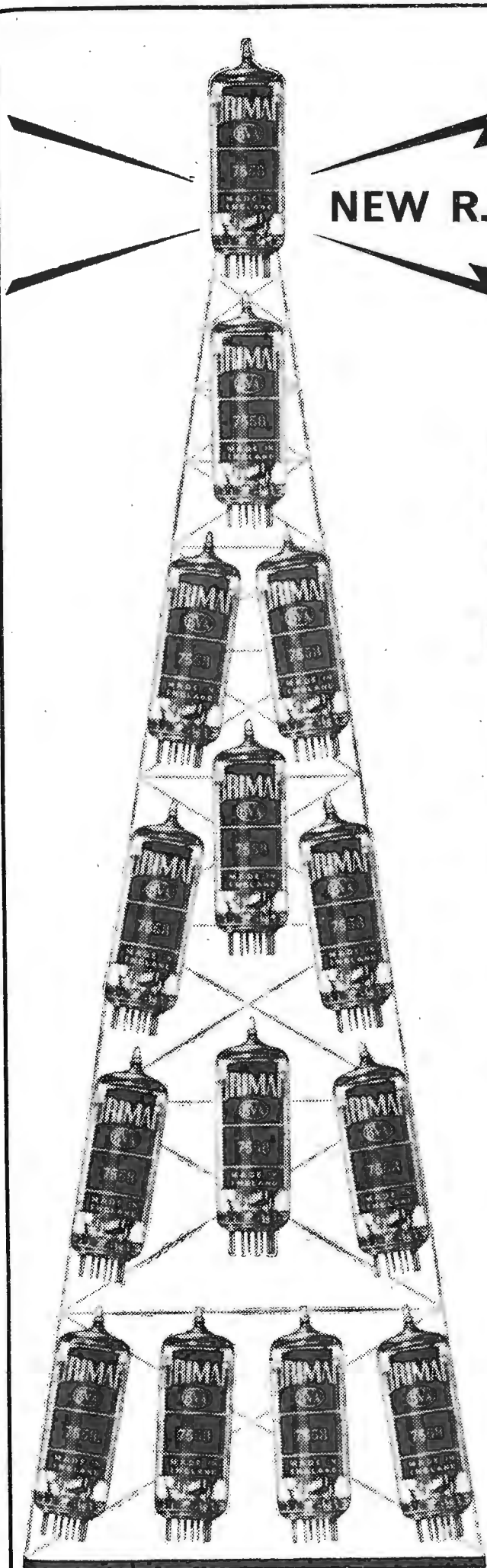

NEW R.F. COMMUNICATIONS VALVE

BRIMAR

7558

**improved POWER PENTODE
operating up to 175 Mc/s**

for use as an R.F. Amplifier · Oscillator · Frequency Multiplier
or in A.F. Modulator and Amplifier applications

Heater Voltage Vh 6.3 V
Heater Current Ih 0.8 A

TYPICAL OPERATION

		Push Pull A.F. Amplifier (Values for 2 Valves)	R.F. Power Amplifier Class C FM Telephony at 175 Mc/s	Frequency Doublers to 175 Mc/s	
Anode Voltage	Va	300	250	250	V
Screen Grid Voltage	Vg2	250	200	200	V
Control Grid Voltage	Vg1	-21	-40	-53	V
Grid Resistor	Rg1		27	53	kΩ
Peak R.F. Grid Voltage	vg1(pk)		47	60	V
Peak A.F. Grid Voltage	vg1(pk)-vg1(pk)	40			V
D.C. Anode Current	Ia	40	60	50	mA
D.C. Screen Grid Current	Ig2	2.0	3.7	2.6	mA
D.C. Control Grid Current (Approx.)	Ig1		1.5	1.0	mA
Effective Load Resistance (Anode to Anode)	Ra-a	5.0			kΩ
Driving Power (Approx.)	Pdr		1.0	0.4	W
Useful Power Output	Pout	20.5	6.5	3.0	W
Total Harmonic Distortion	Dtot	5.0			%

Please ask for Data sheets

Thorn-AEI Radio Valves & Tubes Ltd.

HEAD OFFICE: 155 CHARING CROSS ROAD LONDON, W.C.2 Telephone: GERrard 9797

BRIMAR EXPORT DIVISION: THORN HOUSE UPPER ST. MARTIN'S LANE LONDON, W.C.2



For instrumentation
within your budget,
 in laboratories
 or in production,
Philips Oscilloscopes GM 5602 and GM 5603

provide
 precision performance
 at reasonable cost.

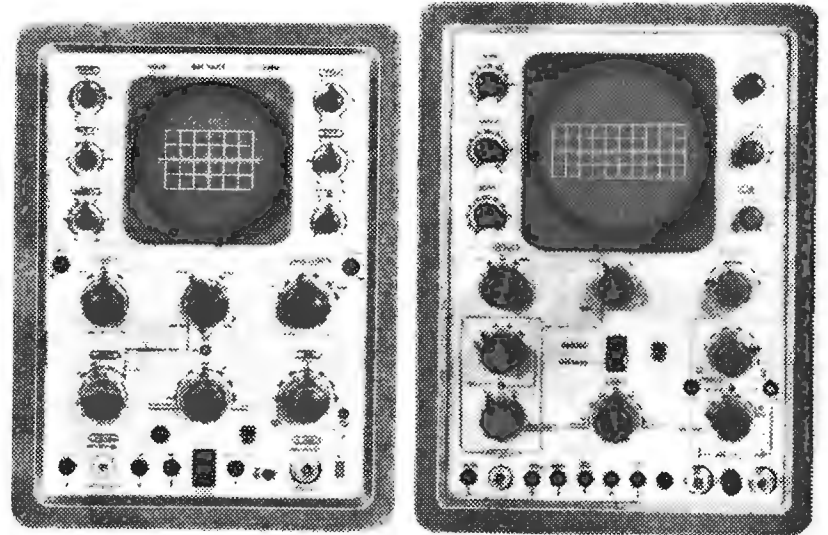

Main specification	GM 5602	GM 5603
Bandwidth	DC - 14 Mc/s	DC - 14 Mc/s
Sensitivity	50 mV/cm - 5 V/cm (3 %)	50 mV/cm - 5 V/cm (3 %)
Differential input	No	Yes
Signal delay	300 ns	300 ns
Sweep speeds	40 ns/cm - 2.5 s/cm	40 ns/cm - 2.5 s/cm
Magnifier	2x, 5x	2x, 5x
Trigger facilities	int. + and -, ext. + and - Mains freq. + and -	int. + and -, ext. + and - Mains freq. + and -
Cathode ray tube	10 cm (4in) 4 kV acc. volt.	13 cm (5in) 10 kV acc. volt.
Accessories supplied	Cathode follower probe Attenuator probe Cables, viewing hood.	2 cathode follower probes 2 attenuator probes Cables, viewing hood.

For extended facilities, a range of optional accessories and auxiliary instruments is available:

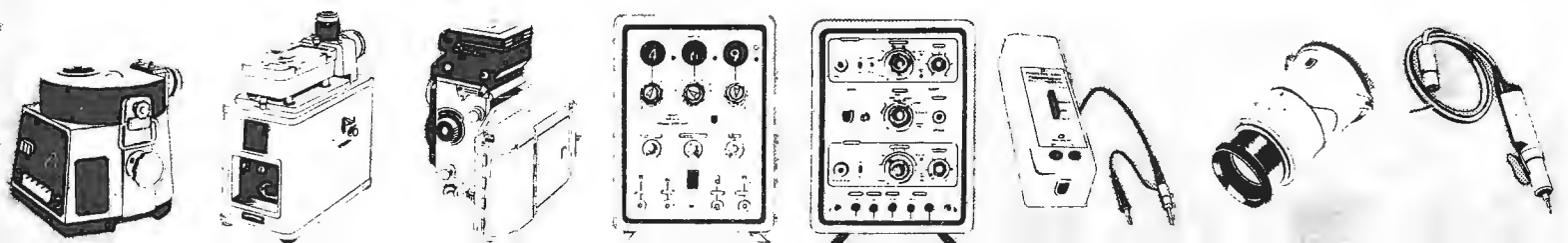

High precision
Recording
Camera PP 1021

Standard
Recording
Camera PP 1014

Multi-purpose
photographic
equipment
PM 9300

Trigger delay
Unit GM 4585

Electronic
Switch PP 1071

Pre-amplifier
PM 6041

Projection lens
PM 9301

Extra Probes



PHILIPS

electronic measuring instruments

Sales and Service all over the world

Sole distributor for the U.K.: **Research and Control Instruments Ltd.**, 207 Kings Cross Road, LONDON WC1

For the Republic of Ireland: **Philips Electrical (Ireland) Ltd.**, Newstead, Clonskeagh, DUBLIN

Overseas enquiries please, to the manufacturers, **Philips, Ema Department**, EINDHOVEN, Holland

2 W W - 117 FOR FURTHER DETAILS.

sender units are mounted in the grooves provided in the turbine blade discs for balancing purposes. Power is conveyed into the capsule by induction transfer between a stationary primary winding and a number of secondary pick-up coils on the rotating disc. A gap of $\frac{1}{4}$ in or more exists between the two winding cores, and a nice design compromise was required between the low coupling factor due to the gap demanding a high frequency and the increase in eddy current loss with frequency. A frequency of about 50 kc/s has been adopted; with three capsules an input of 70 W is necessary to feed them with a total supply of $4\frac{1}{2}$ W. The modulated radio signals are picked up in a comparable fashion. Designed for a nominal frequency of 30 Mc/s, a small output loop in the outer face of the capsule transmits to the stationary transmission line coupling loop. This ingenious parallel line feeder/aerial system is terminated by its characteristic impedance, and gives uniform pick-up sensitivity over its whole circumference except at the termination. This particular difficulty was overcome by placing a compensating capacitive pick-up at the receiving end termination.

In operation, capsule lives in excess of 2,000 hours have been shown to be possible. Trouble due to "temporary g" failures—temporary fade-out of signals—has occurred. The mechanism involved is not clear, but an explanation was put forward by Mr. M. K. Kingery, of the Arnold Engineering Development Center. The experimental programme undertaken in this connection was, in effect, to "squeeze potted transistors", which resulted in their characteristics being "destroyed" for the time being, but recovering after an appreciable hysteresis period.

The paper on piston engine research telemetering, by Associated Engineering Limited, showed how development had gone along parallel lines to those adopted by C.E.R.L. The sender, working at 86 Mc/s, is small enough to be fitted inside the piston of a standard 4-cylinder 1,500 c.c. petrol engine, is encapsulated, and supplied from a mercury cell mounted on the gudgeon pin so that the acceleration forces are across the width of the cell and the plate faces and not perpendicular to them. The cells are constructed with high temperature seals; despite the high acceleration and temperature conditions an operating life of 5 hours is obtained.

With a much more severe radio propagation problem than C.E.R.L., fluctuations in signal strength are countered by the employment of a very wide, fast-acting a.g.c. system which has to cope with the 60 dB change which occurs between the two extreme positions of the piston relative to the crankcase aerial. In the receiver the Foster-Seeley discriminator covers a bandwidth of 400 kc/s with a constant slope, while a high gain a.f.c. system is provided which has a range of some 5 to 6 Mc/s.

Biomedical Telemetering

The paper on biomedical telemetering by Professor Mackay of the University of California was of considerable value on several counts. Not the least of these was the comprehensive list of references beginning with his original contribution (with B. Jacobson) "Endoradiosonde", published in *Nature*, June 15, 1957.

Professor Mackay indicated that work on the "radio pill" had been going on for over ten years.

The first experiments were carried out with "passive transmitters" in the period before suitable transistors became available. By using a resonant combination of an inductive pick-up and a condenser, variations in the resonant frequency due to changes in the physical quantity being measured could be detected as with the grid-dip wavemeter, and these instruments were, in fact, employed for sensing these changes.

The development of the transistor type of transmitter was also traced with particular reference to reduction in size. The possibility of producing such a unit capable of being implanted in the human eye without damage appears to represent the achievement of a point well along the asymptote to the infinitesimal.

Oceanography

The rapidly growing recognition of the need to set up oceanographic telemetering networks on a worldwide basis is a natural result of the corresponding increase in the importance of oceanography. In particular, the U.S. contributions to the session on "Geophysical and Biomedical Systems" showed that an advanced stage of planning has been reached on an international scale. Technically the systems have much in common with those used for public utility supervisory schemes. A widely distributed group of buoys telemeter the required data e.g. temperature, pressure, salinity, etc. back to a shore station which interrogates them at suitable intervals. Because of the ranges involved and associated system design considerations, it is planned to use frequency bands in the 4-23 Mc/s section of the h.f. band for oceanographic telemetering. The h.f. band is, at present, probably the most congested of any, and the demands for space in it continue to grow. Consequently the oceanographer will be competing for bandwidth with a large number of users, many of them representing public services. Nevertheless his claims appear to be such that at least a part of his requirements may well be met in the near future.

A far from tenuous link exists between oceanography and earth satellites such as the Canadian "Alouette" topside ionosphere sounder. Its main purpose is to measure, as implied by its functional name, the electron density distribution from above the ionosphere. The paper given on this satellite elicited major interest, especially with regard to the ground-based telecontrol system used with it. Reliability had proved to be extremely high. Launched from the Pacific Missile Range in California on September 29th, 1962, less than 0.1% failure had been experienced on telecontrol commands over this period. The telecontrol system is based on a 7-tone command unit, the tones, lying in the audio range, are applied sequentially as amplitude modulation of the v.h.f. carrier. The decision to adopt telecontrol had been found to have been amply justified, not least for the way in which power could be switched off during the gaps between station passes to keep within the power capacity limitations of the solar cells. The overall policy which had been adopted was influenced strongly by the need to make the command, telemetering, and tracking systems of the satellite compatible with the chain of N.A.S.A. Minitrack stations; and had as a guiding principle the concept of "keeping the complexity on the ground".

R.E.Y.



SALON INTERNATIONAL RADIO-TÉLÉVISION

PARIS 1963

"Deuxième Chaîne" Prospects Attract Record Crowds

AFTER missing a year the Paris radio exhibition reopened with renewed vigour from 5th to 15th September this year as an international show—in fact as well as in name. Rumours that this would be in effect a Franco-German exhibition turned out to be a malicious exaggeration. We hope it did not originate in the U.K. because Ferguson were the only firm who made the effort to show what Great Britain can produce. We congratulate them on doing something to make direct contact with the French buying public and on the excellent decor of their large stand. Well mixed with the 197 stands of French manufacturers were 49 firms from Germany, Holland, Denmark, Spain, Italy, Switzerland, Austria, Japan, the U.S.A. and the U.K.

We visited the Salon on the last Saturday of the period and in spite of warm sunshine found the ticket offices besieged. The organizers do not disguise their surprise at the success of this year's show as measured by the number of visitors which, helped by a fairly generous issue of invitations, reached a total of 400,000 when the show closed—nearly double the number at the previous exhibition in 1961.

The French broadcasting authority R.T.F. gave massive support to the

exhibition with special television programmes originating both in the hall and in the adjoining Palais des Sports with its aluminium domed roof and seating capacity of 6,000. Demonstrations were also given of the work of R.T.F. in assisting the development of broadcasting in the African countries, and of the work of their technical research departments. In common with most of the European radio and electronics shows this year there were exhibits dedicated to past history as well as to the future. The Centre National d'Etudes des Télécommunications had arranged a sequence showing the evolution of electricity and magnetism, and there were tableaux contrasting amateur transmitters, portable receivers, etc., of yesterday and today. The future was epitomized by a beautifully made model of the steerable horn antenna used for satellite reception at Pleumeur Bodou.

But most of the interest shown by the public was in the forthcoming second programme in Band IV on 625 lines, and throughout the period of the exhibition programmes were transmitted both on v.h.f. (819 lines) and u.h.f. (625 lines) to demonstrate the capabilities of the receivers shown on the stands. The ambient lighting in the main

hall was reduced so that picture quality could be better appreciated.

Although schedules from the Paris transmitter on channel 22 will continue daily for the purpose of receiver adjustment they will be mainly stills and test cards, but experimental programmes for the public will commence on 4th January 1964 and will continue each Saturday evening and each Sunday afternoon and evening until April 1964 when a full service will be established in the environs of Paris. At the same time experimental transmissions will start in Lyons-Fourvieres and before the summer of 1964 will be followed by transmissions from Lille, Marseille and Clermont-Ferrand.

All leading French television receiver manufacturers have either adapted their receivers for the addition of a u.h.f. tuner and a switched line timebase or are already selling sets fully equipped for the second programme. In this they are technically and chronologically on a par with British manufacturers. As in Belgium and Holland, multi-standard sets are also available and the firm of Singer SNR were showing a model (TM 18) which was claimed to receive *all* European systems, though on closer examination we noticed that 405 lines was not listed! Many sets make use of the twin-panel

plastic-coated type of display tube, usually described as *auto-filtrant*, but by Grammot as *ecran endochromatique anti-reflet*. Continental Edison showed a receiver with 70cm (27½in) tube and there was one example of projection television by Pyrus Télémonde to show that this system still has its adherents. A few portable television receivers made their appearance, one of the most interesting being the French-designed Célard "Radiotélécapte" which uses transistors, has an 8in display tube, is adjustable to five different European standards and will also receive medium- and long-wave radio stations. It measures 14½ × 13 × 8¼in and weighs 21 lb.

Célard were also showing an all-transistor table model television receiver taking only 24 watts from batteries or 50 watts from mains which uses a 23in, 110° tube and provides piano-key selection of the two 819-line and three 625-line European standards. The 32 transistors and 22 diodes are mounted in printed circuits which are hinged for access to both sides.

Colour television was not in evidence in the main exhibition, but we heard that private demonstrations were given of long-distance relaying (Paris-Marseille-Paris) of colour tests, designed to show the quality and stability of the SECAM system under these conditions.

Accessories to television were numerous and included a Fresnel-type magnifier (Beamscope) marketed by Pizon Bros. giving 30% increase in picture size, and a wide variety of television tables. Some of these, e.g. Voltam, are extremely functional

since their somewhat thick tops contain voltage regulators which seem to be necessary in France, due to the supply voltage variations in some districts. Other firms showing *reglateurs de tension* were Ducretet-Thomson, Dynatra, Opalec and Ribet-Desjardins. An effective ultrasonic remote control system which successfully overrode the high exhibition background noise was demonstrated by the Belgian firm of Cobar. So that visitors could see the working of the mechanism at close quarters, this set was demonstrated with the back off!

There was little new to report in the field of radio reception. Hardly anything was heard of stereophonic broadcasting, in spite of the lead given by R.T.F. in starting experimental broadcasts four years ago on a single radio channel. The authorities have evidently decided that their efforts to provide a good monophonic f.m. service are not yet sufficiently appreciated, and publicity was quite strongly directed towards *modulation de fréquence* as such. The majority of portables are of the hand-carrying rather than the vest-pocket type and in this respect the trend in France is similar to that noted in other European countries.

A trend peculiar to France is the *valise électrophone stéréo* of which upwards of 30 different makes were to be seen. This is a record player with twin loudspeakers which fit together to look rather like a piece of expensive airline luggage and which, at the drop of a catch (and connection to the nearest mains socket), gives extremely good sound quality. Inquiries of several firms as to who

bought these outfits, which are so good to look at while in transit, and why they were carried around, did not produce any satisfactory answer. "*Nous ne savons pas, mais ils sont très populaire.*"

There is a strong *haute fidélité* movement in France, but the Radio and Television Salon is not really their show (this, the International Festival of Sound, will be held in the Palais D'Orsay next year from 12th to 17th March). However, one or two examples of high-power and high-quality sound amplifiers were noted. The Harmon Kardon (American) 50W+ amplifier, for instance, shown by Dyna Empire Inc., was demonstrating what these ratings mean in terms of millibars in the auditory meatus. Grundig (German) were also collecting appreciative crowds by the sonority of their larger "music chests". Among the native French products Teppaz, whom one has hitherto associated with inexpensive portable record players, were giving more emphasis to the public address side of their activities and showed a wide range of valve power amplifiers with graphical direct indication of tone control characteristic settings, and also a range of transistor amplifiers for either 6V (7 watt output) or 12V (15 watts) supplies.

The Paris Radio Show is, more than most, a retail sales show where visitors are encouraged to sit down and settle final details of a purchase there and then. From the amount of business we saw being conducted in this way we can appreciate the organizers' and exhibitors' satisfaction with this year's event.

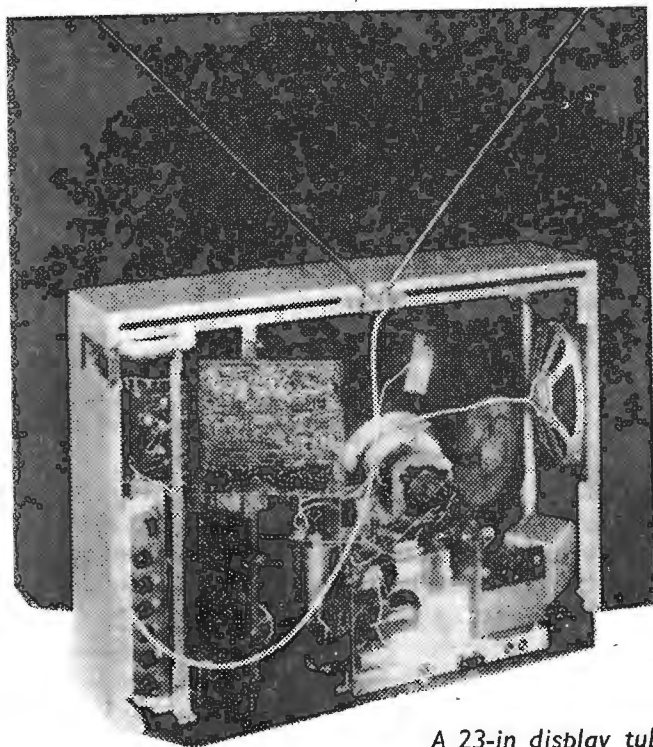

A 23-in display tube is used in the Célard "Télécapte 59" transistor multi-standard television receiver.

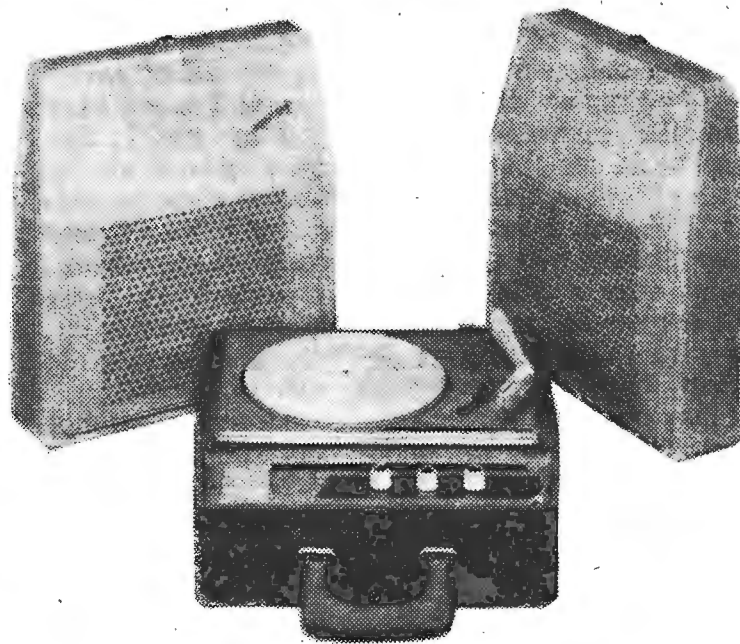

Schneider "Zambra", an example of the "stereo valise" portable record players now popular in France.

Why Coaxial Cables?

By "CATHODE RAY"

EVER since I wrote a two-part treatise on r.f. cables 13 years ago and it was reissued in the book "Second Thoughts on Radio Theory," I have complacently assumed that the subject was covered. Those who were at home with hyperbolic functions had plenty of books from which to choose, and those who weren't could, I hoped, get what they wanted from my simpler though less elegant treatment. So I was surprised and slightly disconcerted the other day to get a letter from someone who declared that he had read the said treatment in "Second Thoughts" and it hadn't helped him.

He went on to ask quite a lot of questions, and although I felt a few points were in fact covered by what he had read he did succeed in convincing me that there was a gap in available teaching on the subject.

It is no good (it seems) to clarify, beyond even the capacity of the dimmest to misunderstand, the

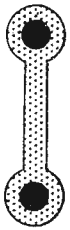

Fig. 1. Section of type of parallel-wire cable sometimes used for linking television set with aerial.

mysteries of reflection coefficient, standing wave ratio, characteristic impedance, quarter-wave transformers, etc., if you omit to mention what it is all in aid of.

This is how, 13 years ago, I began:

"Now that television is going ahead in a big way, more and more people are having to become acquainted with the fact that for connecting the aerial to the set one cannot just use any old bit of wire." If I'd had my ear closer to the ground I might have heard the insistent rejoinder "Why not?" But I just went on: "One has to use a special sort of 'feeder' cable, and it must have the right impedance." Again, I missed the cries of "Why?" and plunged straight into the technicalities of impedance.

Now, after a delay that only a cable to the stars and back would provide, but without its attenuation, comes the simple query: Why is a coaxial cable needed? Why not the ordinary electric sort?

It may not have escaped notice that my questioner was concerned about *coaxial* cables, whereas my treatise was entitled "R.F. Cables." Although the two things have a large overlap, they far from completely coincide. Not all r.f. cables are coaxial and not all coaxial cables are for r.f. (which stands for radio frequency). But it was clear that the inquirer meant r.f. coaxial cables. I pointed out to him that parallel-wire cables or transmission lines are preferred for some r.f. purposes.

Talking about purposes, although I mentioned television—because it is by far the most familiar

—there are others. Wherever r.f. power or signals have to be transmitted over a significant distance with as little loss as possible, that is where r.f. cables or lines are used. In radio communications and radar equipment, for example.

What, in this context, is a significant distance? It would be quite wrong to give the answer in yards, or even metres—unless the frequency or wavelength was known. The general answer would be: Something more than a very small fraction of a wavelength. How about 5 yards—or, what is nearly the same, 5 metres—for example? If this was anything over, say, one twentieth of a wavelength it would be significant. 20 times 5 being 100, that works out to include all wavelengths less than 100 metres. If you think in frequencies, you will divide 300 million by this and say: Oh, yes! 3 Mc/s. As a matter of fact it isn't quite so simple as that, because 300 million is (in round figures) the number of metres travelled by light and radio waves per second *in empty space*. Along a cable, which is what we are talking about, they travel slower. How much slower depends on the kind of cable, and that we don't know; but 200 million metres per second is near enough for most r.f. cables. Recalculating the lowest frequency for which 5 metres of cable is certainly a significant distance, we get 2 Mc/s. For some purposes even one-twentieth of a wavelength would be too large a fraction, and 2 Mc/s therefore not the lowest frequency for which 5 metres of cable would matter.

I can imagine my questioner asking, "Why?"

The waves take time, however short, to move from A to B, so there is a phase difference between the two points, and it is this phase difference that is the significant thing. For most purposes even one twentieth of a cycle (18°) is appreciable.

Fig. 2. (a) Unbalanced and (b) balanced termination for parallel-wire line.

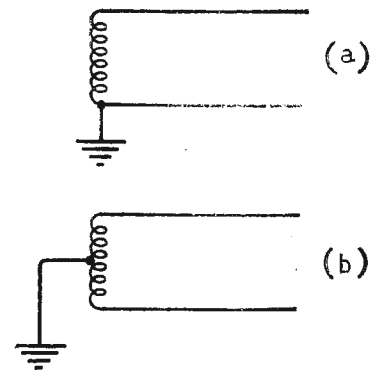

And so we find that a few inches don't matter very much at the frequencies used for television—at least, on the present bands I and III—but they matter a lot with centimetre waves. At the other extreme, a mile of cable would introduce only about one fourteenth of one degree of phase difference at power frequency (50 c/s.).

Going back to where we got involved in this question of distance, we should note that the first require-

ment of the cable is that it should transport r.f. power with negligible loss. There are three different ways in which it can lose power. The most obvious, perhaps, is in the cable itself; due to the resistance of the conductors to current flowing through them and the behaviour of the insulating materials to capacitive currents. There can also be loss by radiation—and, to the extent that there is, liability to interference entering such cable used to link a receiver with its aerial. Lastly there is the more involved subject of impedance mismatching. This doesn't so much actually waste power as limit the amount transmitted, to something less than the maximum possible.

It is in these respects that the cables used at power frequencies—or even telephone frequencies—are likely to be found wanting. Not that the resistance of the conductors is likely to be excessive, though one does have to bear in mind that at very high frequencies the surface rather than the whole substance carries most of the current. (There is no time just now to explain why; if you don't know, look up "Skin Effect" in any good book on radio.) But dielectric losses are of major importance.

That is easy enough to understand, because every inch of the cable is a capacitor into which current is driven by any voltage between the two conductors. The amount of such current, for a given voltage, is directly proportional to the frequency. So at 50 Mc/s it is a million times as much as at 50 c/s. If the space between the conductors were a vacuum there would be no waste of power (though of course the capacitance current has a profound effect on the behaviour of the cable), and the same is very nearly true for air. But one can't keep the conductors apart by a vacuum, or even by air; something more substantial is needed, and whatever is used wastes a proportion (called the power factor) of the power flowing to and fro through the cable's capacitance.

At 50 c/s so little power does flow this way that there is no need to worry much about its power factor; if the material is chosen to resist voltage breakdown successfully, its power factor should be low enough. Not only is power factor enormously more important at r.f., in proportion to the frequency, but the power factor of some materials itself increases with frequency. That is why such care has to be taken to choose cable insulating materials for r.f., and especially for v.h.f. and microwaves. The development of polythene during the war deserves the description "breakthrough" more than many things so described, because it combines extremely low v.h.f. power factor with flexibility over a wide range of temperature.

Even the best solid material wastes some power—and costs some money—so there is a double incentive to use as little of it as possible. In most types of r.f. cable it is limited to disk or cup shaped spacers at intervals along it, or it takes the form of a continuous spiral cord—there are many ingenious designs. Obviously there must be sufficient solid material so placed as to prevent the conductors from touching or (in power feeders) getting close enough for a flash-over, but the requirement is more rigorous than that because it is necessary to maintain the capacitance per inch at the same figure throughout or there will be mismatching trouble.

Power feeders such as those used to take the output from a television transmitter up the tower

to the aerial need not be flexible (in fact, should not be) and are on such a scale that they can be built up of rigid rods and cylinders, with very little solid insulation. When many kilowatts of power are to be carried, one doesn't want to waste even a few per cent of it.

Next, there is the reason for the coaxial form. Why not use ordinary twisted flex? Well, in the first place flex is usually insulated by p.v.c., which has much too high a power factor. Presumably that could be got over by substituting polythene. Next, the conductors are so close together that the capacitance per inch is large, tending to cause a large loss, and also resulting in an inconveniently low impedance for matching the things the wire is connected to. Probably, too, the capacitance would not be very constant, and certainly it would be increased wherever the wire was placed close to metal structures.

Some of these disadvantages are reduced by spacing the wires apart as shown in Fig. 1, and parallel-wire

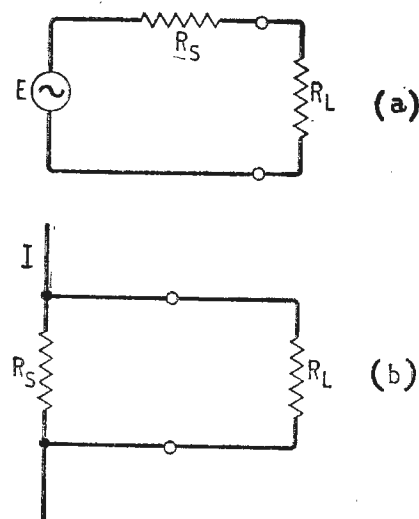

Fig. 3. (a) Constant-voltage generator and load system and their simplest equivalent forms.

feeder of this kind is used for television receivers, etc., where cheapness is important. But the need to keep it away from other conductors is even greater, and the absence of twist results in greater radiation and possibility of interference. On a larger scale, parallel wires or rods separated mainly by air and supported by insulators rather like overhead telephone wires are sometimes used at radio frequencies, but rarely at very high ones.

That brings us to the questions of radiation and interference. They are both the same question really, so far as the characteristics of the line are concerned; a line that radiates a lot is open to accept a lot of interference, just as the receiving ability of an aerial can be found by measuring its radiating ability, and *vice versa*. Although far more people use r.f. lines for receiving than for transmitting, the two-fold question can perhaps be discussed more easily in terms of radiation.

Radiation is proportional to the rate at which the electric and magnetic fields are changing; that is to say, the frequency. But frequency is decided on other grounds than minimizing radiation, so is not a possible variable for that purpose. Even a very fast-changing field will not radiate much, however, if it is very close (in terms of wavelength) to its source. It has to spread out. That is why aerials are shaped as they are. Exactly the opposite is in mind when transmission lines or cables are being designed. Fields are inevitable—and indeed essential to the functioning of the line—so the only solution is to make them cancel one another out as completely as

possible at all points more than a small fraction of a wavelength from the conductors.

At such low frequencies as 50 c/s it is not unusual to connect things together with a parallel-wire line, one wire of which is earthed, as in Fig. 2(a). It happens when we use one of the untwisted types of flex for our domestic appliances. If all the current goes via the wires and none via earth, then the wires carry equal and opposite currents; and because they are very close together the mutual cancellation of their magnetic fields is effective everywhere beyond a *very* small fraction of one wavelength (at 50 c/s, 3,750 miles!). But because one wire is earthed and the other is "live", there is an unbalanced electric field between the latter and earth, and consequently a capacitive current that way. So the balance of currents is upset, the mutual cancellation of magnetic fields is imperfect, and there is a spread-out electric field between the live wire and earth as well as the concentrated one between it and the earthed wire. However, the earthed wire provides some screening, and in any case the capacitive current at 50 c/s is negligible, and even if it weren't the radiation at that frequency is negligible.

At v.h.f., however, the wavelength is at least a million times shorter, and the frequency (and therefore the current via a given capacitance) a million times greater. Moreover the wires have to be spaced farther apart if the impedance of the line is not to be inconveniently low—and, in r.f. power lines, if there is to be no flash-over. So there is liable to be a very appreciable inequality in the currents in the wires, and therefore a resultant magnetic field. And the wider spacing would reduce cancellation even if the currents were equal.

Consequently at such frequencies the practice is to earth the centre point, as in Fig. 2(b), so that the wires are at equal and opposite potentials. Then, provided they are both at practically equal distances from any earth, the current balance is maintained and the magnetic fields cancel at distances that are large compared with the spacing between the wires.

To meet other requirements this spacing is likely to be appreciable compared with a wavelength, and

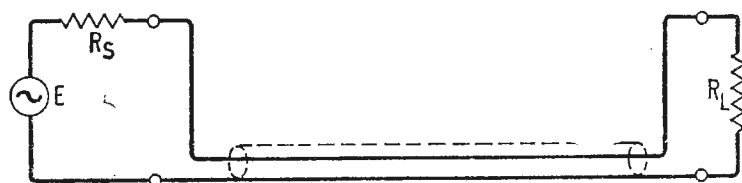

Fig. 4. Modification of Fig. 3 (a) when generator and load are in different places, necessitating a coaxial cable to join them.

so therefore is radiation from this type of line. It is particularly unsuitable if used close to earth—and that, of course, includes all earthed conductive objects.

So where it is important to keep radiation or interference down, the coaxial type is preferred. It has the extra advantage that no centre-tapping is needed; the outer conductor is earthed. So only the inner conductor is at r.f. potential, and as it is entirely surrounded by the outer conductor the electric field is confined to the space between the conductors, and in spite of the unbalanced connection there is no current unbalance. Consequently there is maximum mutual cancellation of magnetic fields, aided by the fact that the outer conductor

is all round the other instead of at one side of it.

Lastly, impedance. Here the governing principle is that when a constant e.m.f. or current is provided by a source, it delivers the maximum power to a load when the impedance of the load is the conjugate of the impedance of the source, and the total power is then shared equally between source and load. That may sound rather alarming, but it is quite simple really. Fig. 3 shows the simplest case, in which the impedances are resistances. (a) is the voltage form, in which E is the constant e.m.f., in series with a fixed source resistance R_s and the load resistance R_L . The theorem says you get the maximum power in R_L when $R_L = R_s$. (b) is the constant-current form, which is equivalent; the circuit of any actual power generator, such as a radio transmitter, can be boiled down into either of these two forms. You would naturally choose the one that was easier to calculate. In general, however, there is some reactance as well as resistance in the source, and the bit about the conjugate means you would have to tune that out by means of an equal amount of the opposite kind of reactance across or in series with the load. (Remember, at any one frequency there is a parallel reactance equivalent to any series reactance; and in this case you choose the one that is easiest or cheapest to provide. Calculations are easiest if both are in series in (a) and in parallel in (b).)

The proof of the theorem is by simple calculus and is given in the textbooks on circuit theory.

The situation we are considering is where the load is some distance from the source, so that an r.f. cable has to be used between them, as in Fig. 4. This cable makes no difference to the power delivered to R_L if (i) its characteristic resistance R_0 is equal to R_L and R_s , and (ii) it is loss-free. Condition (ii) is not entirely possible, but we have already seen how the loss can be minimized, and the makers of the cable usually state it in dB per 100 feet. Condition (i) is ideal because it not only fulfils the impedance-matching theorem but also ensures that the loss in the cable is kept to the unavoidable minimum. However, the cable, or part of it, can be used not only to convey the power across a distance but also to act as a transformer, effecting a match between *unequal* source and load impedances. By suitable choice of R_0 , one can make the resistance of load plus cable equal to R_s , and source plus cable equal to R_L , so achieving perfect matching at both ends. As explained in the treatise on the subject, the greater the transformation ratio the greater the amount of power surging to and fro (indicated by the standing-wave ratio, SWR) besides the steady flow of power from source to load. As a proportion of all the power through the cable is lost, the total loss is thus greater than it need be; so the transformer effect is used only when the distance to be covered is not more than a wave-length or two, or else a quarter-wavelength of special line is used as a transformer to match the resistances at either or both ends to the main cable.

Paradoxically as it may seem, the impedance of the cable would be a pure resistance if the cable were perfectly loss-free. In practical low-loss cables it is almost entirely resistive. The value of R_0 depends on the inductance and capacitance per unit length, which in turn depend on the sizes and spacing of the conductors and the material between them;

(Continued on page 573)

Vortexion
quality equipment

TYPE C.B.L. TAPE RECORDER

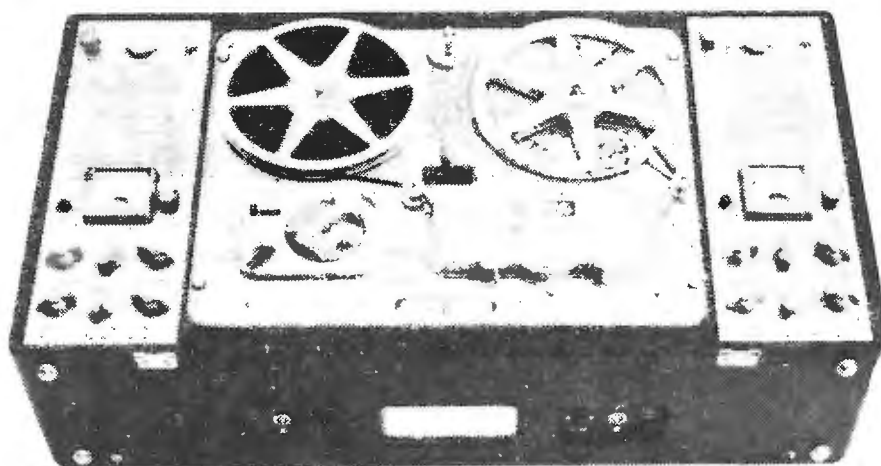

The Vortexion CBL recorder has had many detail improvements and additions using the latest stereo deck, "B" type monitoring, after record facilities with mixing of inputs on each channel and over 6 watts total output. All the usual features of the "B" recorder are retained including metering of bias and signal plus the ability to record the signal from one track to the other together with additional signal from the mixed inputs. The separate 30/50 ohm balanced line microphone inputs allow for the microphones to be placed at any distance apart according to the result required. The right hand channel may be switched off entirely when only single channel working is desired.

The W.V.A. Recorder is a semi-professional model of the highest quality.

The W.V.B. Recorder is suitable for professional use with after record, monitoring and echo facilities.

The Vortexion 30/50 watt Amplifier can deliver 50 watts of speech and music or over 30 watts of continuous sine wave and the main amplifier has a response of 30 to 20,000 cps within 1 db at 0.1% distortion and outputs for 4, 7.5, 15 ohm and 100 volt line. Models are available with two, three or four mixed inputs which may be low impedance balanced line microphones, P.U. or Guitar inputs.

The 120/200 watt Amplifier can deliver its full audio power at any frequency in the range of 30 to 20,000 cps for which the response is accurate within 1 db with less than 0.2% distortion at 1,000 cps. It can be used to drive mechanical devices for which the power is over 120 watts on continuous sine wave. The input is for 1 mw. 600 ohms, the output for 100-120 volts or 200-240 volts and additional matching transformers for other impedances are available.

Other items of our manufacture are:

Erase Fader Unit for above recorders.

4 Way Mixer with 10 watt output and tone controls.

Record and Playback Mixer.

2 x 5 Way Stereo Mixers.

12 Way Mixers.

3 Way Mixer and Peak Programme Meter.

4 Way Mixers.

2 way 30/50 ohm in and out stud type Mixers.

Full details and prices of the above on request.

VORTEXION LIMITED, 257-263 The Broadway, Wimbledon, London, S.W.19

Telephone : LIBerty 2814 and 6242-3

Telegrams : "Vortexion, Wimble, London"

2W W-118 FOR FURTHER DETAILS.

High gain
High electrical stability
High mechanical strength





MAZDA

Frame-Grid

Valves for TV

Low microphony
Low noise
Low characteristic spread

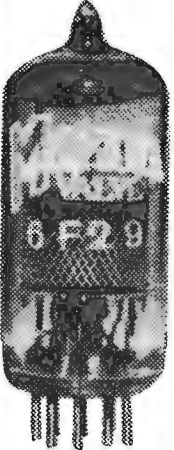
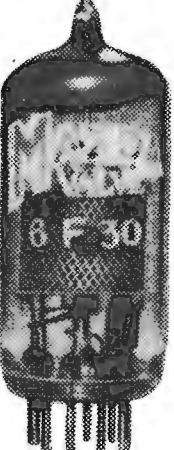
Mazda Frame-Grid Valves offer all the advantages associated with this outstanding manufacturing technique, plus some noticeable extras. Most incorporate a new Mazda cathode coating process which ensures smooth surface textures and gives a final dimensional accuracy of $\pm 4/10$ ths of a thou. Some have tightly controlled variable - mu characteristics to give superior cross modulation performance. These high-performance valves are available for various uses, as detailed below, and are of sound mechanical design. *Please ask for appropriate data sheets.*

					
30L17/PCC806	30C17/PCF87	6F29/EF183	6F30/EF184	6F28/EE80	30FL12/PCE82
Tuner Valves	Low noise · High gain Low cross modulation.	I.F. Valves	High gain Low cross modulation	Video Output Valves	High peak current available High sensitivity Low distortion



Thorn-EMI Radio Valves & Tubes Ltd.

HEAD OFFICE: 155 CHARING CROSS ROAD · LONDON, W.C.2 · Telephone: GERrard 9797

EXPORT DIVISION: THORN HOUSE · UPPER ST. MARTIN'S LANE · LONDON, W.C.2
 2W-119 FOR FURTHER DETAILS.

formulae are given in the books for coaxial and parallel-wire lines. The range of R_o that can be provided is limited by the dimensions that are practical to about $200\ \Omega$ to $650\ \Omega$ for parallel-wire and $40\ \Omega$ to $140\ \Omega$ for coaxial; and to keep loss to a minimum they should not be very far from $600\ \Omega$ and $75\ \Omega$ respectively. That is another reason why, if a widely different value is needed for impedance-matching purposes, its length should be limited to the minimum needed for that purpose—quarter of a wavelength. Yet another reason is that the length of an unmatched (or transforming) line is critical in relation to wavelength, whereas the precise length of a matched line doesn't matter and it can be used for quite a wide range of frequency. Quarter-wave transformers are sometimes used at the aerial end, but other matching devices are more usual at the other end.

Although I am trying not to go over well-trodden ground, it may be helpful to be reminded that the correct R_o for a $\lambda/4$ section to match R_1 to R_2 is $\sqrt{R_1 R_2}$. It may also be helpful to repeat that a mismatch between source and load restricts the power reaching the load; the extent to which it does so is shown in Fig. 5. But if R_L is greater than R_S the efficiency (proportion of total power reaching the load) is greater than the 50% obtainable with a perfect match, so if power efficiency is more important than maximum power this kind of mismatching is deliberately used. R_L lower than R_S not only reduces the amount of power in the load; it reduces the efficiency too, so has nothing to recommend it.

A mismatch at the load end of the line, or anywhere along the line, results in standing waves set up by power reflected towards the source; this increases the power lost in the line, and may also cause "ghosts" in television pictures, false "blips" on

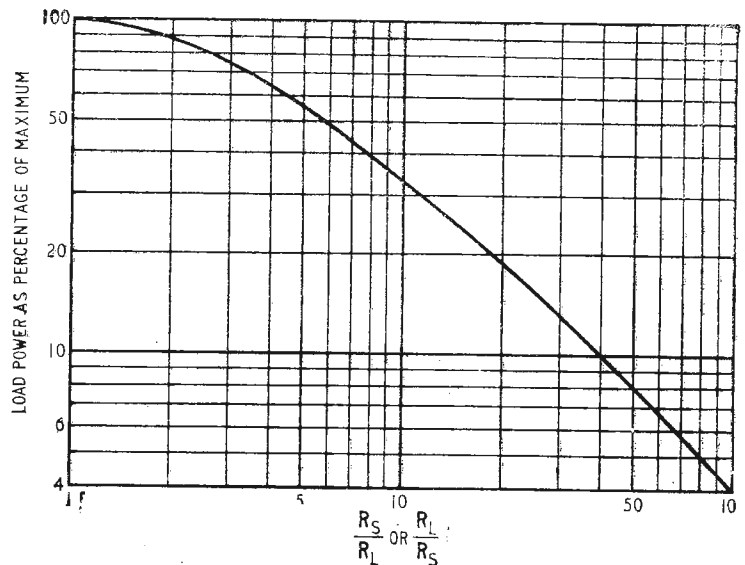
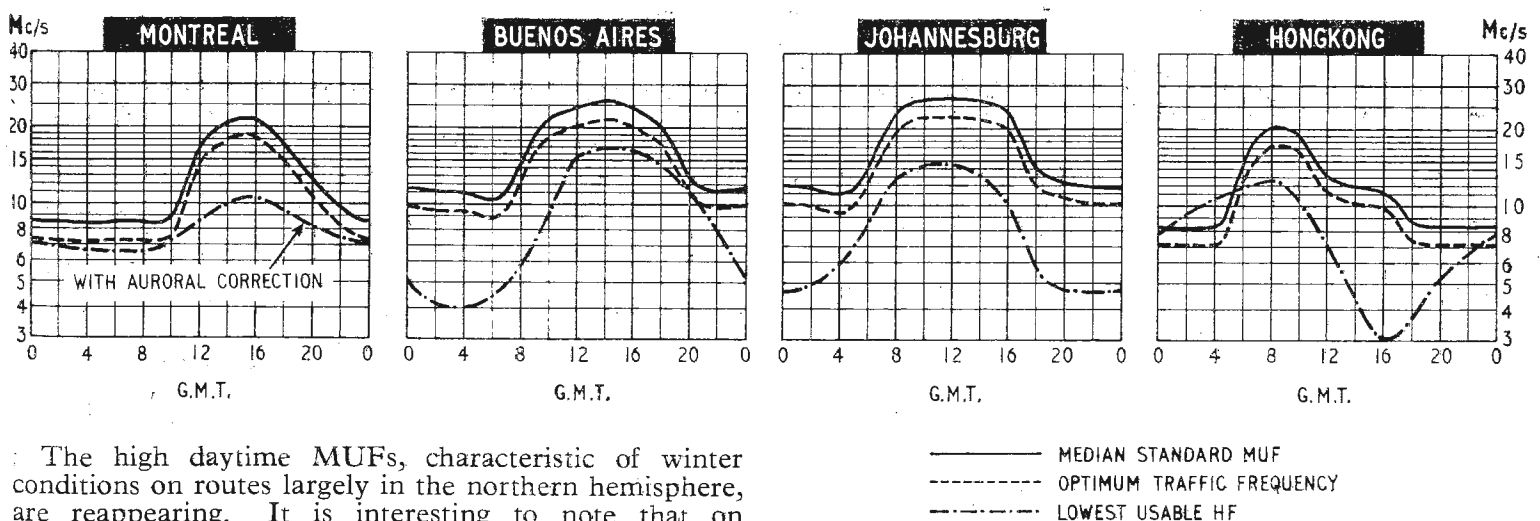

Fig. 5. Graph showing restriction of power due to mismatching. This is a different matter from loss of power.

radar screens, etc. Mismatching occurs wherever there is a change of R_o , and because R_o depends on spacings and dimensions one should take care to avoid sudden changes in these. For instance, where a coaxial line is joined to another or to some equipment, a coaxial plug and socket designed to have the same impedance should be used. Nowadays one can get special (hermaphrodite) coaxial terminals that connect with their own kind, abolishing the need for distinctive plugs and sockets.

I believe I have now covered all the questions put by my correspondent. If any other readers who have joined in are complaining about the lack of explanation of standing waves, etc., may I suggest they read "Foundations of Wireless," 7th edition, Chapter 14?

H. F. PREDICTIONS — NOVEMBER



The high daytime MUFs, characteristic of winter conditions on routes largely in the northern hemisphere, are reappearing. It is interesting to note that on southerly circuits to Africa and South America the highest frequencies in the h.f. band will be of use again, even though the sunspot cycle is close to its minimum.

The prediction curves show the median standard MUF, optimum traffic frequency and the lowest usable high frequency (LUF) for reception in this country. Unlike the MUF, the LUF is closely dependent upon such factors as transmitter power, aerials, local noise level and the type of modulation; it should generally be regarded with more diffidence than the MUF. The

LUF curves shown are those drawn by Cable and Wireless, Ltd., for commercial telegraphy and they serve to give some idea of the period of the day for which communication can be expected.

During the period 13th-23rd September radio conditions were at times violently disturbed by solar flares associated with a large sunspot. Several Dellinger-type fade-outs were followed by a severe ionospheric storm between 20th and 23rd September.

CONFERENCES AND EXHIBITIONS

Latest information on events during next year both in the U.K. and abroad is given below.
Further details are obtainable from the addresses in parentheses.

LONDON

- Jan. 14-17 R.H.S. Halls
Physical Society Exhibition
(Inst. of Physics & Phys. Soc., 47 Belgrave Sq., S.W.1.)
- Feb. 24-28 Savoy Place
Transmission Aspects of Communications Networks
(I.E.E., Savoy Place, W.C.2.)
- Mar. 18-25 Earls Court
Electrical Engineers Exhibition
(Association of Supervising Electrical Engineers, Museum Street, W.C.1.)
- Apr. 2-5 Hotel Russell
Audio Festival & Fair
(C. Rex-Hassan, 42 Manchester Street, W.1.)
- Apr. 8-10 Savoy Place
Dielectrics and Insulating Materials
(I.E.E., Savoy Place, W.C.2.)
- May 5-15 Earls Court
Mechanical Handling Exhibition
(*Mechanical Handling*, Dorset House, Stamford St., S.E.1.)
- May 25-30 Olympia
Instruments, Electronics & Automation Exhibition
(Industrial Exhibitions, 9 Argyll Street, W.1.)
- Aug. 26-Sept. 5 Earls Court
National Radio Show
(Radio Industry Exhibitions, 59 Russell Square, W.C.1.)

BIRMINGHAM

- July 6-9 The University
Signal Processing in Radar & Sonar Directional Systems
(Brit.I.R.E., 9 Bedford Square, London, W.C.1.)

BRIGHTON

- Sept. 14-18 College of Technology
Computer Conference
(British Computer Society, Finsbury Court, Finsbury Pavement, London, E.C.2.)
- Sept. 29-Oct. 1 Hotel Metropole
Battery Symposium
(D. H. Collins, Admiralty Eng'g Lab., W. Drayton, Middx.)

BRISTOL

- Jan. 1-4 The University
Solid State Physics
(Inst. of Physics & Phys. Soc., 47 Belgrave Square, London, S.W.1.)

CAMBRIDGE

- Mar. 17-19 Cavendish Laboratory
Cold Cathode Tubes and their Applications
(Brit.I.R.E., 9 Bedford Square, London, W.C.1.)

CRANFIELD

- Apr. 13-16 College of Aeronautics
Flight Test Instrumentation Symposium
(M. A. Perry, College of Aeronautics, Cranfield.)

EASTBOURNE

- Apr. 26-29 Queens Hotel
R.T.R.A. Conference
(Radio & Television Retailers' Assoc., 19 Conway Street, London, W.1.)

EDINBURGH

- Mar. 31-Apr. 3 Heriot-Watt College
Joint Computer Conference
(British Computer Society, Brit.I.R.E. & I.E.E.)
(Computer Conference Secretariat, I.E.E., Savoy Place, London, W.C.2.)

FARNBOROUGH

- Sept. 7-13 R.A.E.
Air Show
(S.B.A.C., 29 King Street, London, S.W.1.)

NOTTINGHAM

- Sept. 7-11 The University
Magnetism
(Inst. of Physics & Phys. Soc., 47 Belgrave Square, London, S.W.1.)

SOUTHAMPTON

- Aug. 26-Sept. 2
British Association Annual Meeting
(British Assoc. for the Advancement of Science, 3 Sanctuary Buildings, Gt. Smith Street, London, S.W.1.)

TEDDINGTON

- Sept. 23-25 N.P.L.
Fundamental Problems of Low-Pressure Measurements
(Inst. of Physics & Phys. Soc., 47 Belgrave Square, London, S.W.1.)

OVERSEAS

- Jan. 7-9 Washington
Reliability and Quality Control
(R. Brewer, G.E.C. Hirst Research Centre, Wembley, Middx.)
- Jan. 30-31 Chicago
Computer Applications Symposium
(I.I.T. Research Institute, Chicago, 16)
- Feb. 2-11 Rome
Scientific & Technical Documentation & Information
(Comitato Nazionale per la Productivita, Viale Regina Margherita 83D, Rome)
- Feb. 5-7 Los Angeles
Military Electronics Convention
(I.E.E.E., Box A, Lenox Hill Station, New York 21)
- Feb. 7-12 Paris
Electronic Components Exhibition
(F.N.I.E., 23 rue de Lübeck, Paris 16e)
- Feb. 19-21 Philadelphia
Solid-State Circuits Conference
(H. Parks, Martin Co., Mail 683, Baltimore 3, Md.)
- Feb. 26-28 Washington
Scintillation and Semiconductor Counter Symposium
(I.E.E.E., Box A, Lenox Hill Station, New York 21)
- Mar. 12-17 Paris
Festival of Sound
(Syndicat des Industries Electroniques de Reproduction et d'Enregistrement, 14 rue de Staël, Paris 15e)
- April 6-8 Washington
Nonlinear Magnetics
(R. C. Barker, Dept. of Eng. & Applied Science, Yale University, New Haven, Conn.)
- April 19-25 Phoenix
Aerospace Electro-Technology
(A. A. Sorenson, Martin Co., Baltimore 3, Md.)
- April 21-23 Washington
Computer Conference
(J. Roseman, 2313 Coleridge Dr., Silver Spring, Md.)
- May 5-7 Washington
Electronic Components Conference
(Dr. J. Bohrer, International Resistance Co., 401 N. Broad Street, Philadelphia 8, Pa.)
- May 11-13 Dayton
Aerospace Electronics Conference
(I.E.E.E., 1414 E. Third St., Dayton, Ohio)
- May 19-21 New York
Microwave Theory & Techniques
(Leonard Swern, Sperry Gyroscope Co., Great Neck, Long Island, N.Y.)
- May 25-28 Los Angeles
Telemetry Conference
(I.E.E.E., Box A, Lenox Hill Station, New York 21)
- June 2-6 Budapest
Conference on Acoustics
(Hungarian Society for Optics, Acoustics and Filmtechnics, Szabadság tér 17, Budapest, V.)
- June 8-10 New York
Symposium on Quasi-Optics
(J. Fox, Polytechnic Institute of Brooklyn, 55 Johnson Street, Brooklyn 1)

June 18-20 Precision Electromagnetic Measurements (I.E.E.E., Box A, Lenox Hill Station, New York 21)	Boulder	Oct. 12-16 Instrument-Automation Conference (W. H. Kushnick, 212 Sixth Avenue, Pittsburgh 22, Pa.)	New York
June 26-28 Automatic Control Conference (I.E.E.E., Box A, Lenox Hill Station, New York 21)	Stanford	Oct. 19-21 National Electronics Conference (N.E.C., 228 N. La Salle St., Chicago, Ill.)	Chicago
Sept. 7-11 Microwaves, Circuit Theory & Information Theory (Dr. K. Morita, Oki Elec. Indus. Co., 4 Chome Nishi-Shibaura, Minato-Ku, Tokyo)	Tokyo	Oct. 21-23 Aerospace & Navigation Electronics (I.E.E.E., Box A, Lenox Hill Station, New York 21)	Baltimore
Sept. 14-16 Military Electronics (I.E.E.E., Box A, Lenox Hill Station, New York 21)	Washington	Oct. 29-30 Electron Devices (I.E.E.E., Box A, Lenox Hill Station, New York 21)	Washington
Sept. 22-24 Antennas & Propagation (H. Jasik, Jasik Labs., 100 Shames Dr., Westbury, N.Y.)	Long Island	Nov. 12-15 Solar Symposium (The University of Sydney, Australia)	Sydney
Oct. 4-9 Space Electronics (C. H. Doersam, Jr., Instruments for Industry, Hicksville, L.I., N.Y.)	Las Vegas	Nov. 16-18 Engineering in Medicine and Biology (Dr. P. Frommer, Genl. Hospital, Cincinnati 29, Ohio)	Cleveland
Oct. 7-12 Communication Congress (Civico Institute Colombiano, Palazzo Tursi, Genoa)	Genoa	Nov. 16-19 Magnetism & Magnetic Materials (I.E.E.E., Box A, Lenox Hill Station, New York 21)	Minneapolis
		Dec. 2-4 Technical Progress in Communication Wires & Cables (H. H. Kingsley, R. & D. Lab., Fort Monmouth, N.J.)	Asbury Pk., N.J.

AUTOMATIC 100 POLAROID LAND CAMERA

UNLIKE most automatic cameras in which the current from a photocell operates the "leaves" of an iris diaphragm, the new Polaroid 100 has a fixed aperture and the exposure time is varied by a transistor circuit. The exposure time is determined by the average scene lighting and the manufacturers claim that the camera can produce perfectly exposed pictures under any lighting conditions, including flash, and that the system is more robust and accurate than the direct iris control method which involves delicate meter mechanisms of almost "microamp sensitivity."

As it can be seen from the diagram, two transistors are used in the

shutter mechanism, one acting as a hold-on device and the other as a switch. Tripping the shutter button causes two things to happen; first, it trips the "operating" blade and, secondly, it closes the battery switch which allows the hold-on transistor VT2 to conduct and pass current to the electromagnet. The magnet pulls the "closing" blade to one side and allows light to reach the negative material, and at the same time the capacitors in the base circuit of the switching transistor VT1 are allowed to charge. The rate at which they charge is dependent upon the resistance of the photocell, which, of course, varies with the intensity of light on its surface. As the capacitors charge, the base potential of the switching transistor rises and once the transistor conducts it shorts the base potential of the hold-on transistor. This disconnects the battery and the "closing" blade returns to its original position to block the path of light to the negative material to

complete the exposure cycle. The capacitors are shorted when the shutter is re-cocked and to enable the shutter to handle films of various speeds, different combinations of capacitance are selected in addition to changing the aperture.

There are times when an overall meter reading of the whole scene will not give the desired results, as it may be necessary to emphasize darker or lighter parts of the scene. This is achieved in this camera by internally placing filters of differing densities over the photocell.

For those who are photographically minded, the picture format remains at $3\frac{1}{2} \times 4\frac{1}{4}$ in. Monochrome and colour film packs are available for the camera and, unlike its forerunner, the actual processing is done outside the camera. The time to process monochrome pictures remains at ten seconds and colour pictures take 50 seconds.

2WW 301 for further details.

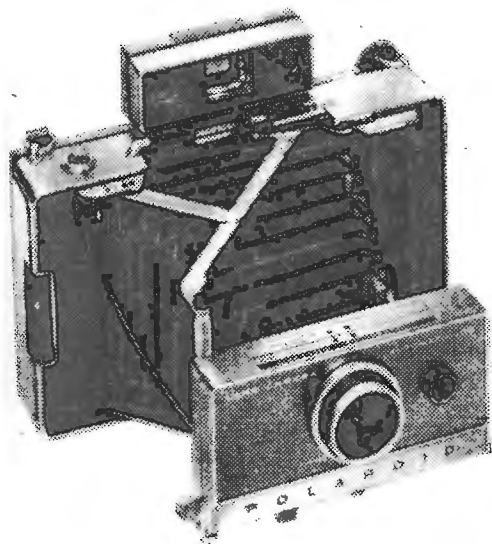

Above: The new Polaroid 100 camera and (right) simplified schematic diagram of the camera shutter mechanism shown in the open position with the magnet holding the "closing blade".

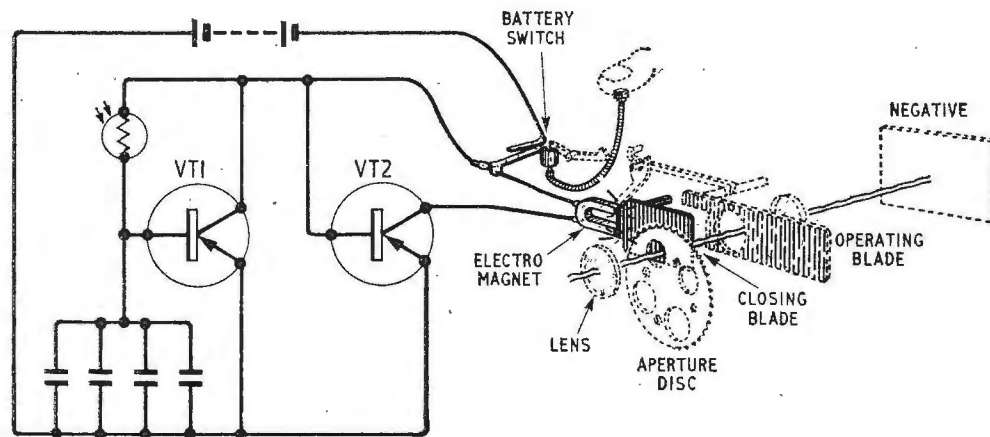

NOVEMBER MEETINGS

Tickets are required for some meetings: readers are advised, therefore, to communicate with the secretary of the society concerned.

LONDON

6th. I.E.E. & Brit.I.R.E.—Colloquium on "Logic circuits for digital computers" at 2.30 at Savoy Place, W.C.2.

6th. Brit.I.R.E.—"Bandwidth compression systems for speech transmission" by J. S. Williams at 6.0 at the London School of Hygiene and Tropical Medicine, Keppel Street, W.C.1.

8th. Junior Institution of Engineers.—"Research in space science" by J. Heywood at 7.0 at Pepys House, 14 Rochester Row, Westminster, S.W.1.

13th. I.E.E.—Colloquium on "Parametric amplifiers" at 10.0 at Savoy Place, W.C.2.

13th. Brit.I.R.E.—"Human factors in industrial design" by W. D. Cain and R. W. Stevens at 6.0 at the London School of Hygiene and Tropical Medicine, Keppel Street, W.C.1.

13th. Society of Instrument Technology.—"The N.P.L. mekometer—distance measurement by means of a light beam modulated at microwave frequency" by R. H. Bradsell at 7.0 at Manson House, 26 Portland Place, W.1.

14th. Radar & Electronics Assoc.—"The radar story" with contributions from Sir Robert Watson-Watt, Sir John Cockcroft, Dr. F. E. Jones, Gp. Capt. E. Fennessy and Gp. Capt. Philip Dorte at 7.0 at the Royal Society of Arts, John Adam Street, W.C.2.

15th.—I.E.E.—Discussion on "Synthesis of transfer functions" opened by R. J. A. Paul and P. L. Taylor at 5.30 at Savoy Place, W.C.2.

15th. Institute of Navigation.—"Long-range radio aids to navigation" by J. R. Mills at 5.30 at the Royal Institution of Naval Architects, 10 Upper Belgrave Street, S.W.1.

15th. Television Society.—"The k-rating of television equipment and networks" by B. W. Osborne, A. M. Peverett and D. A. R. Wallace at 7.0 at the I.T.A., 70 Brompton Road, S.W.3.

18th. I.E.E.—"The colour performance of the Secam colour television system" by G. B. Townsend at 5.30 at Savoy Place, W.C.2.

18th. I.E.E. Graduates.—"Electronic telephone exchanges" by M. T. Hills at 6.30 at Savoy Place, W.C.2.

20th. I.E.E.—"Computers in control of processing—the coming revolution in industry" by Dr. D. N. Truscott at 5.30 at Savoy Place, W.C.2.

20th. Brit.I.R.E.—Short contributions on "Systematic selection procedures for technical courses" at 6.0 at the London School of Hygiene and Tropical Medicine, Keppel St., W.C.1.

22nd. Institution of Electronics.—"Printed circuit techniques" by P. Millet at 7.0 at the London School of Hygiene and Tropical Medicine, Keppel Street, W.C.1.

25th.—I.E.E.—Colloquium on "Recent advances in d.c. amplifiers" at 2.30 at Savoy Place, W.C.2.

27th. I.E.E.—Discussion on "The application of electronic building bricks" opened by I. V. Idelson and Prof. J. E. B. Gray at 5.30 at Savoy Place, W.C.2.

27th. Brit.I.R.E.—Annual General Meeting at 6.0 followed by the presidential address of J. L. Thompson at the London School of Hygiene and Tropical Medicine, Keppel St., W.C.1.

27th. British Kinematograph Soc.—"Electronic cam. system—vidicon cameras as electronic view-finders on 35mm cameras" by D. Robertson at 7.30 at the Central Office of Information, Hercules Road, S.E.1.

28th. I.E.E.—"The results of tests at Goonhilly with the experimental earth satellites Telstar and Relay" by F. J. D. Taylor, W. J. Bray and R. W. White at 5.30 at Savoy Place, W.C.2.

28th. I.E.E.—Discussion on "Consideration of the practical applications of lasers" opened by Dr. Denis Taylor and Dr. R. P. Howson at 5.30 at Savoy Place, W.C.2.

29th. Television Society.—"Television receiver design trends" discussion opened by P. L. Mothersole at 7.0 in the I.T.A. Conference Suite, 70 Brompton Road, S.W.3.

ARBORFIELD

21st. I.E.E.—"The impact of modern ionospheric research on communications" by G. Millington at 5.0 at the Garrison Hall, Arborfield Camp.

BASINGSTOKE

28th. Brit.I.R.E.—"Principles and practice of data logging" by R. F. Martin at 7.30 at the Technical College.

BIRMINGHAM

21st. Brit.I.R.E.—"Principles and uses of silicon controlled rectifiers" by R. J. Bland at 6.15 at the Electrical Engineering Dept., The University.

BRISTOL

12th. Brit.I.R.E.—"Non-destructive testing" by Dr. A. Nemet at 6.30 at the College of Science and Technology.

14th. Society of Instrument Technology.—"The application of digital computers to on-line control in the process industries" by G. H. Laycock at 7.30 in the University Physics Dept., The Royal Fort.

CARDIFF

6th. Brit.I.R.E.—"Teaching machines, their circuitry and techniques" by D. Rowntree at 6.30 at the College of Advanced Technology.

CAMBRIDGE

14th. I.E.E.—"The satellite environment and the implication which it has for electronic design" by Dr. A. P. Willmore at 8.0 at the Engineering Laboratories, Trumpington Street.

28th. I.E.E.—"Electronics—the expanding frontier" by Dr. R. C. G. Williams at 8.0 at the Engineering Laboratories, Trumpington Street.

CHESTER

25th. I.E.E.—"Development of the Atlas computer" by Dr. D. B. G. Edwards at 6.30 at the Town Hall.

EDINBURGH

6th. I.E.E. & Brit.I.R.E.—"Lasers" by Dr. A. C. Moore at 7.0 at the Department of Natural Philosophy, The University.

12th. I.E.E.—"Opto-electronics" by G. G. Scarrott at 7.0 at the Carlton Hotel, North Bridge.

26th. I.E.E.—"Stereophonic broadcasting systems" by Dr. G. J. Phillips at 7.0 at the Carlton Hotel, North Bridge.

GLASGOW

7th. I.E.E. & Brit.I.R.E.—"Lasers" by Dr. A. C. Moore at 7.0 at the Institution of Engineers and Shipbuilders, 39 Elmbank Crescent, C.2.

11th. I.E.E.—"Opto-electronics" by G. G. Scarrott at 6.0 at the Royal College of Science and Technology.

GRANGEMOUTH

14th.—Society of Instrument Technology.—"Solid-state instruments for process control" by L. C. Towle at 7.0 at the Leapark Hotel, Bo'ness Road.

HENLOW

18th. I.E.E. & Royal Aeronautical Soc.—"The Sun, the earth and radio" by J. A. Ratcliffe at 7.0 at the R.A.F. Technical College.

"WIRELESS WORLD" PUBLICATIONS

	Net Price	By Post
PRINCIPLES OF SEMICONDUCTORS M. G. Scroggie, B.Sc., M.I.E.E.	21/-	21/11
COLOUR TELEVISION: N.T.S.C. System, Principles and Practice. P. S. Carnt, B.Sc. (Eng.), A.C.G.I., A.M.I.E.E. and G. B. Townsend, B.Sc., F. Inst.P., M.I.E.E., A.K.C.	85/-	87/3
RADIO VALVE DATA Compiled by the staff of "Wireless World." 7th Edition	6/-	6/10
RADIO AND ELECTRONIC LABORATORY HANDBOOK M. G. Scroggie, B.Sc., M.I.E.E. 7th Edition	55/-	57/3
PRINCIPLES OF TRANSISTOR CIRCUITS S. W. Amos, B.Sc.(Hons.), A.M.I.E.E. 2nd Edition	21/-	22/-
HIGH-QUALITY SOUND PRODUCTION AND REPRODUCTION. H. Burrell Hadden.	42/-	43/5
SOUND AND TELEVISION BROADCASTING. General Principles. K. R. Sturley, Ph.D., B.Sc., M.I.E.E.	45/-	46/4
GUIDE TO BROADCASTING STATIONS Compiled by "Wireless World." 13th Edition	3/6	4/-
WIRELESS SERVICING MANUAL 10th Edition W. T. Cocking	25/-	26/-

A complete list of books is available on application.

Obtainable from all leading booksellers or from

ILIFFE BOOKS LTD., Dorset House, Stamford Street, London, S.E.1.

IPSWICH

7th. I.E.E.—“Stereophonic broadcasting systems” by Dr. G. J. Phillips at 7.30 at Electric House.

LEEDS

27th. I.E.E.—“Microminiaturization” by Dr. J. W. Granville at 6.30 at the University Electrical Engineering Dept.

LEICESTER

12th. Television Society.—“Servicing tape recorders” by A. W. Rowe at 7.30 in the Main Hall, Vaughan College, St. Nicolas Street.

13th. Brit.I.R.E.—“Digital techniques” by A. C. Elliott at 6.45 at The University.

LIVERPOOL

20th. Brit.I.R.E.—“Electronics in archaeology” by D. Reaney at 7.30 at the Walker Art Gallery.

LOUGHBOROUGH

26th. I.E.E.—“Optical masers” by I. L. Davies at 6.30 at the Union Building, College of Technology.

MANCHESTER

6th. I.E.E.—“Solid circuits” by R. I. Walker at 6.15 at the Reynolds Hall, College of Science and Technology.

7th. Brit.I.R.E.—“Spark erosion techniques” by Dr. D. W. Rudorff and G. V. Smith at 7.0 at the Reynolds Hall, College of Science and Technology.

19th. I.E.E.—“Data processing” by R. H. Tizard at 6.15 at the Reynolds Hall, College of Science and Technology.

NEWCASTLE-UPON-TYNE

4th. I.E.E.—“The general problems of f.m. multi-channel communications” by R. G. Medhurst at 6.30 at the Rutherford College of Technology, Northumberland Road.

13th. Brit.I.R.E. — “Laboratory microphones” by W. J. Parker at 6.30 at the Institute of Mining and Mechanical Engineers, Westgate Road.

18th. I.E.E.—“Satellite astronomy” by Prof. R. L. F. Boyd at 6.30 at the Rutherford College of Technology, Northumberland Road.

NORWICH

4th. I.E.E.—“Semiconductor static switching” by D. D. Jones at 7.30 at the Assembly House.

PLYMOUTH

13th. Brit.I.R.E. & I.E.E.—“The field effect transistor and its applications” by C. S. den Brinker and D. Ellison at 6.30 at the College of Technology.

PORTSMOUTH

21st. I.E.E.—“Semiconductor devices—progress and recent applications” by J. J. Limb and J. F. Spilling at 6.30 at the College of Technology.

SOUTHAMPTON

12th. I.E.E.—“Electronic telephone exchanges” by Dr. J. E. Flood at 6.30 at The University.

13th. Brit.I.R.E.—“The development and application of ultrasonic cleaning” by A. E. Crawford at 6.30 at the Lanchester Theatre, The University.

STONE

18th. I.E.E.—“Optical masers” by I. L. Davies at 7.0 at Duncan Hall.

NEW MOULDED BODY MINIATURE SWITCHES

★ FULL MAINS RATING

★ 25,000 OPERATIONS

★ TESTED TO 2,000 VOLTS

★ HIGH QUALITY INSULATION

★ COMPETITIVE PRICES

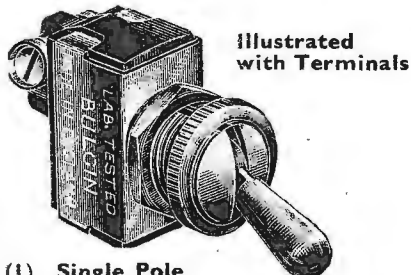

(1) Single Pole Toggle Switches with Standard Bush.

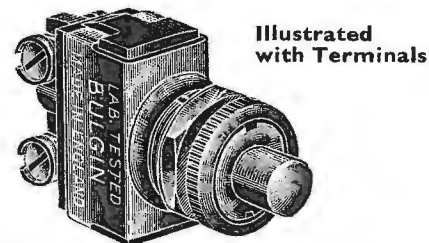

(2) Single Pole Push Switches with Standard Bush.

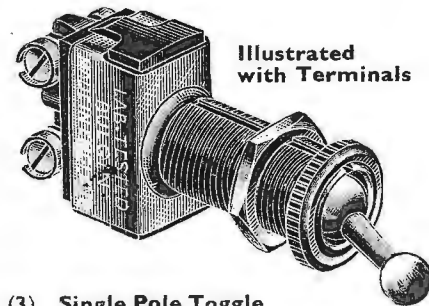

(3) Single Pole Toggle Switches with Extra Long Bush.

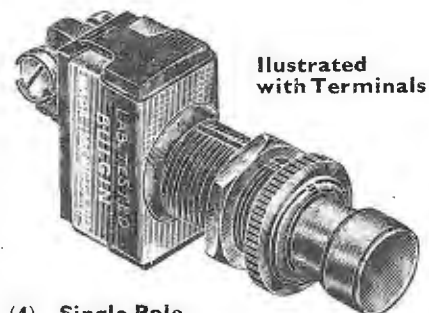

(4) Single Pole Push-Push Switches with Long Bush.

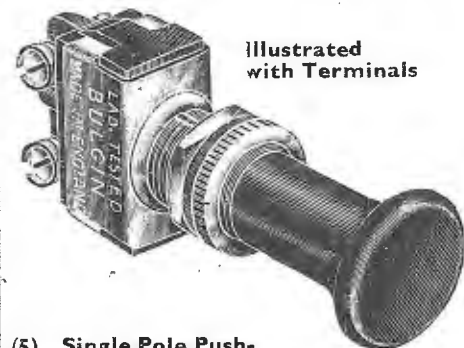

(5) Single Pole Push-Pull Switches with Standard Bush.

Forty years of experience in the manufacture of Miniature Switches has enabled us to develop this new range of over 50 varieties of **Moulded Insulation Switches** that may be relied on for at least 25,000 operations.

Conforming to very high standards of mechanical and electrical operation they are provided with brilliant Nickel-Chrome plated Dollies, Rings, etc., all moulded Phenolic Insulation, Metal Clad cases, and heavily Silver Plated contacts.

Terminal models are fitted with cup-washers to prevent wire straying and tag models are hooked for easy wiring and quick soldering.

Proof Test = 2,000V. at 50 cycles per sec., Insulation resistance \geq 100 M Ω dry or recovered at 500V. Conforming to international 4 mm. *creepage* requirements.

LIST NOS. AND SWITCHING ARRANGEMENTS AVAILABLE AGAINST TYPES ILLUSTRATED.

- (1)
 List No. S.M.265 (S.P.C.O.)
 List No. S.M. 259 (S.P.M.B.)
 List No. S.M.273 (S.P.C.O. Biased)
 List No. S.M.315 (S.P.M.B. Biased OFF)
 List No. S.M.314 (S.P.M.B. Biased ON)

- (2)
 List No. S.M.357 (S.P.C.O. Push for C.O.)
 List No. S.M.365 (S.P.M.B. Push for ON)
 List No. S.M.366 (S.P.M.B. Push for OFF)

- (3)
 List No. S.M.482 (S.P.C.O.)
 List No. S.M.480 (S.P.M.B.)
 List No. S.M.492 (S.P.C.O. Biased)
 List No. S.M.490 (S.P.M.B. Biased OFF)
 List No. S.M.491 (S.P.M.B. Biased ON)

- (4)
 List No. S.R.M. 265 (S.P.C.O.)
 List No. S.R.M.259 (S.P.M.B.)

- (5)
 List No. S.M.445 (S.P.C.O.)
 List No. S.M.443 (S.P.M.B. Pull for OFF)
 List No. S.M.444 (S.P.M.B. Pull for ON)

All List Nos. above are for switches with Solder Tags. If required with Screw Terminals (as illustrations) add /TERM to List No.

FOR DETAILS OF THE FULL RANGE SEND FOR LEAFLET No. 1517/C

A. F. BULGIN & CO. LTD.
 BYE-PASS ROAD, BARKING, ESSEX, ENGLAND
 Telephone: R1Ppleway 5588 (12 lines)

2W W-120 FOR FURTHER DETAILS.



By "FREE GRID"

Masts are a "Must"

SOME of the aerials which are being produced in readiness for the u.h.f. television service scheduled to start next April are formidable-looking affairs, and will undoubtedly place quite a strain on our chimney stacks especially in a high wind. The leverage exerted by these lengthy rows of bird perches will be quite considerable even without the pigeons or seagulls which will inevitably rest upon them.

Because of this I would have expected architects of new houses to have included in their plans specially strengthened chimney stacks designed to withstand the inevitable crowbar effect, but, from observations I have made in various districts, they have not.

If any of you know of any houses being built in which the architect has been "with it" sufficiently to make special provision for u.h.f. aerials, I shall be very grateful if you will let me know. Maybe I can then induce the Editor to pay my fare and hotel expenses there, more especially if "there" happens to be in an attractive part of the country.

To my mind the thing needed for the support of one of these elongated u.h.f. aerials is a tubular steel mast with its root planted firmly in the house foundations, and rising up through the roof well above chimney height. This would not only give strength to withstand the leverage of the long boom or booms likely to be needed in some fringe areas, but would also give us that extra height which will be so much needed for adequate reception of these quasi-optical wavelengths.

Another advantage would be that the hollow steel mast would provide an ideal conduit for the downlead. Also, since the mast will pass through all floors, probably by the side of the chimney breast, an aerial outlet socket could be provided for use in bedrooms.

Dog Eats Dog

IT is no part of my business to discuss or criticize television or sound programmes except when some speaker ventures into the field of wireless technology, and says something which it would be almost criminal for me to let pass without comment. An instance of this occurred a few weeks ago in the B.B.C.'s regular weekly TV programme "It's my opinion".

In this programme, as most viewers will know, a number of prominent people are gathered on a platform in front of an audience of local people, the venue being changed every week. On this particular occasion—at Worcester—the question cropped up of the noisome nuisance of transistor sets on beaches and elsewhere.

To my surprise one of the platform celebrities said a friend of his had developed a pocket transistor set with which he caused a cacophonous caterwauling to come from all nearby transistor sets inducing their owners to switch them off. The speaker added that this special "dog-eats-dog" transistor device was not yet available to others.

The obvious inference was that it would soon be on the market, and it was equally obvious the device was a small modulated oscillator. It did not seem to occur to the speaker that his friend was breaking the law by deliberately causing interference and also by installing and operating an unlicensed transmitter. Furthermore, by inferring that these devices would soon be on the market, his friend was preparing to commit yet another legal offence namely, inciting others to commit the same offence as he was doing at present. Personally, I think a court would also hold the B.B.C. guilty as an accessory by permitting this broadcast. In essence it would be the same as if the B.B.C. allowed a housebreaker to give a talk on how to pick locks and then hint that special lock-picking tools like his would be available to all.

Juan Fernandez 1963

NO doubt many of you will have noticed a recent item of news telling how a company director in a London-bound express train desiring to send an urgent telegram, was advised by the guard to write it out and enclose it in a hollowed-out potato obtained from the kitchen of the restaurant car. This potato was then thrown out as the train was passing a signal box.

I had a somewhat similar experience long years ago as I recounted in these columns in October 1947. My mind did not, however, turn to potatoes but to the traditional method used by sailors when cast away on desert islands, namely a bottle. I proposed to put my message and my money into a bottle obtained from the restaurant car and to hurl it out when the train was

speeding through a wayside station. I was, however, deterred by the guard who quoted a regulation prohibiting the hurling of bottles from train windows.

This recent potato incident has served to remind me how astonishing it is that in these days when we can speak across half the world by radio, the passenger in a British non-stop train is as isolated as was Robinson Crusoe.

It is surely high time that not only a telegraph station but also telephone kiosks should be installed in our trains. It might be difficult to establish a direct radio link but surely it would be possible to devise an induction system between the train and the various conductors which run adjacent to the line. If necessary a special conductor could be strung along the neighbouring telegraph poles. Such an arrangement would probably do much to prevent future train robberies. As things are, the passengers and crew of a train on the move—at least in this country—are really as isolated as was Alexander Selkirk, the prototype of Robinson Crusoe, in his unenviable position on the island of Juan Fernandez as long ago as 1704.

Typographical Tranquillity

THOSE of you who went to the Open Day at the G.P.O. Research Station at Dollis Hill during September will probably have noticed, as I did, a machine that can speak the typed words that are fed into it. I did not, however, see any machine that did the opposite, namely, type the words that are spoken into it.

I am very sorry about this, as it is a machine which would be very useful to me, as I am not very expert with either pen or typewriter. It may be argued of course, that the answer to my requirements is a tape recorder, but this still requires the services of a tea-and-face-powder-consuming young lady to act as intermediary. Nowadays we have very good electric typewriters, and it only needs the introduction of an electronic phono-typist to convert the average office into a haven of all-male tranquillity.

Another electronic machine being shown at the G.P.O. Research Station was one, of which the eventual purpose is to read handwriting. No doubt the Editor is already weighing the cost of such a machine against the time spent in deciphering my handwriting.